

LECTURE NOTES
ON
THERMAL ENGINEERING-1



SRI SAGAR KUMAR BEHERA, LECTURER
DEPARTMENT OF MECHANICAL ENGINEERING
GOVERNMENT POLYTECHNIC,GAJAPATI- 761201

CONTENTS:

SL.NO	CHAPTER NO.	TOPIC
1.	CHAPTER-1	Thermodynamic concept & Terminology
2.	CHAPTER-2	Laws of thermodynamics
3.	CHAPTER-3	Properties processes of perfect gas
4.	CHAPTER-4	Internal Combustion engine
5.	CHAPTER-5	Air standard cycle
6.	CHAPTER-6	Fuels and combustion

Course outcomes

At the end of the course students will be able to:

CO	Statement
C204.1	Explain significance of thermodynamic properties in order to analyze a thermodynamic system.
C204.2	Explain & apply first & second law of thermodynamics in Closed & Open system.
C204.3	Explain & apply gas laws applicable to perfect gas in order to determine thermodynamic properties.
C204.4	Develop an understanding of working principle of 2 stroke & 4 stroke C.I Engine and S.I. Engine .
C204.5	Draw P-V & T-S diagram of different gas power cycle & calculate efficiency thereafter.

Chapter-1

Thermodynamic concept & Terminology

INTRODUCTION:

- Thermodynamics is the science that deals with heat and work and those properties of substance that bear a relation to heat and work.
- Thermodynamics is the study of the patterns of energy change. Most of this course will be concerned with understanding the patterns of energy change.
- More specifically, thermodynamics deals with (a) energy conversion and (b) the direction of change.

Basis of thermodynamics is experimental observation. In that sense it is an empirical science. The principles of thermodynamics are summarized in the form of four laws known as zeroth, first, second, and the third laws of thermodynamics.

- Thermodynamics comes from two greek words Thermi & Dynamic. Thermi means heat & dynamic means power or work by motion.

Macroscopic and Microscopic Approaches:

- Microscopic approach uses the statistical considerations and probability theory, where we deal with “average” for all particles under consideration. This is the approach used in the disciplines known as kinetic theory and statistical mechanics.
- In the macroscopic point of view, of classical thermodynamics, one is concerned with the time-averaged influence of many molecules that can be perceived by the senses and measured by the instruments. The pressure exerted by a gas is an example of this. It results from the change in momentum of the molecules, as they collide with the wall. Here we are not concerned with the actions of individual molecules but with the time-averaged force on a given area that can be measured by a pressure gage.
- From the macroscopic point of view, we are always concerned with volumes that are very large compared to molecular dimensions, and therefore a system contains many molecules, and this is called continuum. The concept of continuum loses validity when the mean free path of molecules approaches the order of typical system dimensions.

Thermodynamic systems:

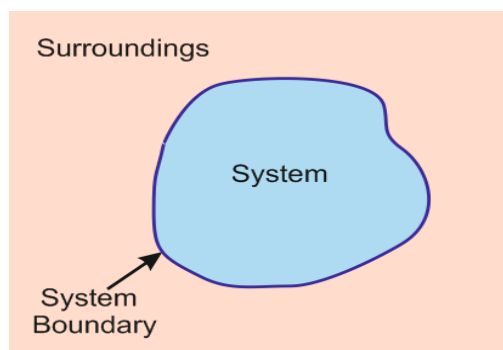

A Thermodynamic system is defined as the fixed mass or fixed region in space upon which our study is focused. A specified region in a space upon which attention is focused for thermodynamic analysis is known as a system.

We introduce boundaries in our study called the system and surroundings. The boundaries are set up in a way most conducive to understanding the energetics of what we're studying. Defining the system and surroundings is arbitrary, but it becomes important when we consider the exchange of energy between the system and surroundings.

Surroundings: Everything external to the system is called Surrounding.

Boundary: It is a real or imaginary surface which separates system from the surroundings. A boundary can be fixed or movable. A boundary has no thickness, no mass and no volume.

Two types of exchange can occur between system and surroundings:

- (1) energy exchange (heat, work, friction, radiation, etc.) and,
- (2) matter exchange (movement of molecules across the boundary of the system and surroundings).

Based on the types of exchange which take place or don't take place, we will define three types of systems:

- **isolated systems:** no exchange of matter or energy.
- **closed systems:** no exchange of matter but some exchange of energy.
- **open systems:** exchange of both matter and energy.

Thermodynamic Property :

In thermodynamics a property is any characteristic of a system that is associated with the energy and can be quantitatively evaluated.

- The property of a system should have a definite value when the system is in a particular state.
- Thermodynamic property is a point function.
- Properties like volume of a system that depend on the mass of a system are called extensive properties.
- Properties like pressure or temperature which do not depend on the system mass are called intensive properties.
- The ratio of extensive property to the mass of the system are called specific properties and therefore become intensive properties.
- Substance can be found in three states of physical aggregation namely, solid, liquid and vapor which are called its phases.
- If the system consists of mixture of different phases, the phases are separated from each other by phase boundary.
- The thermodynamic properties change abruptly at the phase boundary, even though the intensive properties like temperature and pressure are identical.

Pressure (p):

A fluid exerts on a surface element dS of a wall a force of pressure perpendicular to dS , directed outwards with a norm equal to $p dS$, where by definition p is the pressure of the fluid.

The force of pressure, which is a force, a vector quantity the SI unit of which is the Newton, should not be confused with the pressure, a scalar quantity whose **SI unit is the Pascal(N/M²)**. At thermodynamic equilibrium, the system must specifically be at mechanical equilibrium.

Temperature (T):

Temperature is a measure of the average kinetic energy of the atoms or molecules in the system. The unit of measurement in the International System of Units (SI) is the kelvin. Kelvin is, therefore, the unit used by scientists. It is frequent to see it referenced as a **Kelvin degree**.

The basic units (SI Units)

- Mass----kg.
 - Mole----The mole is the amount of substance that contains as many atoms (or molecules) as there are atoms in 0.012 kg of carbon-12.
 - Length—m.
 - Time: second (s)
 - SI unit of temperature is Kelvin (abbreviated as K). The Kelvin is defined as the fraction of 1/273.16 of the thermodynamic temperature of the triple point of water. The relation between Kelvin and Celsius temperature is $K = C + 273.15$ (The triple point of water is at 0.01 C).
 - Force: $1 \text{ N} = 1 \text{ kg m/s}^2$,
 - Pressure, $1 \text{ Pa} = 1 \text{ N/m}^2$, $1 \text{ bar} = 10^5 \text{ Pa}$, $1 \text{ atm.} = 101.325 \text{ kPa} = 760 \text{ mm of HG}$
- In thermodynamics we are concerned with absolute pressure.

Gauge pressure = absolute pressure – atmospheric pressure.

Ordinary vacuum gauge pressure = atmospheric pressure – absolute pressure.

Volume (V):

The volume of a thermodynamic system typically refers to the volume of the working fluid, such as, for example, the fluid within a piston. Changes to this volume may be made through an application of work, or may be used to produce work. **SI unit of volume is M^3 .**

Internal Energy :

- The molecule as a whole can move in x, y and z directions with respective components of velocities and hence possesses kinetic energy.
- There can be rotation of molecule about its center of mass and then the kinetic energy associated with rotation is called rotational energy.
- In addition the bond length undergoes change and the energy associated with it is called vibrational energy.
- The electron move around the nucleus and they possess a certain energy that is called electron energy.
- The microscopic modes of energy are due to the internal structure of the matter and hence sum of all microscopic modes of energy is called the internal energy.

Bulk kinetic energy (KE) and potential energy (PE) are considered separately and the other energy of control mass as a single property (U).

The total energy possessed by the body is given by:

$$E = KE + PE + U$$

Intensive & Extensive properties:

- An intensive property is one that does not depend on the mass of the substance or system.
- Temperature (T), pressure (P) and density (ρ) are examples of intensive properties.

Intensive Property Examples;

The properties of matter that do not depend on the size or quantity of matter in any way are referred to as an intensive property of matter. Temperatures, density, color, melting

and boiling point, etc., all are intensive property as they will not change with a change in size or quantity of matter. The density of 1 liter of water or 100 liters of water will remain the same as it is an intensive property.

- An extensive property of a system depends on the system size or the amount of matter in the system.

If the value of the property of a system is equal to the sum of the values for the parts of the system then such a property is called extensive property. Volume, energy, and mass are examples of extensive properties.

Extensive Property Examples;

There are properties such as length, mass, volume, weight, etc. that depend on the quantity or size of the matter, these properties are called an extensive property of matter and their value changes if the size or quantity of matter changes. Suppose we have two boxes made up of the same material, one has a capacity of four litres while the other has a capacity of ten litres. The box with ten litres capacity will have more amount of matter as compared to that of a four-liter box.

Extensive property	Symbol	SI units	Intensive property	Symbol	SI units
Volume	V	m^3 or L	Specific volume	v	m^3/kg or L/kg
Internal energy	U	J	Specific internal energy	u	J/kg
Entropy	S	J/K	Specific entropy	s	J/(kg·K)
Enthalpy	H	J	Specific enthalpy	h	J/kg
Gibbs free energy	G	J	Specific Gibbs free energy	g	J/kg
Heat capacity at constant volume	C_v	J/K	Specific heat capacity at constant volume	c_v	J/(kg·K)
Heat capacity at constant pressure	C_p	J/K	Specific heat capacity at constant pressure	c_p	J/(kg·K)

Specific properties derived from extensive properties

Thermodynamic process:

A process is path followed by a system in reaching a given final state of equilibrium state starting from a specified initial state.

An actual process occurs only when the equilibrium state does not exist.

An ideal process can be defined in which the deviation from thermodynamic equilibrium is infinitesimal. All the states the system passes through during a quasi-equilibrium process may be considered equilibrium states.

For non-equilibrium processes, we are limited to a description of the system before the process occurs and after the equilibrium is restored.

- A process is said to be reversible if both the system and its surroundings can be restored to their respective initial states by reversing the direction of the process.

- **reversible:** if the process happens slow enough to be reversed.
- **irreversible:** if the process cannot be reversed (like most processes).
- **isobaric:** process done at constant pressure
- **isochoric:** process done at constant volume
- **isothermal:** process done at constant temperature
- **adiabatic:** process where heat transfer is zero. ($q=0$)
- **cyclic:** process where initial state = final state

Thermodynamic State: A system is said to exist in a definite state if all the properties of the system (*pressure, temperature, volume etc.*) have fixed values. If any one of the property changes, the system changes to another state.

Example: At 1 atm pressure and 10 degree centigrade water is in solid state (mixed state)
At 1 atm pressure and 110 degree centigrade it is vapour state.

Thermodynamic Path: The series of states passed through by the system during a change from one equilibrium state to another. Change of state of a system is the consequence of any operation in which properties will change. The series of states through which system passes during a change of state is called the path of the process.

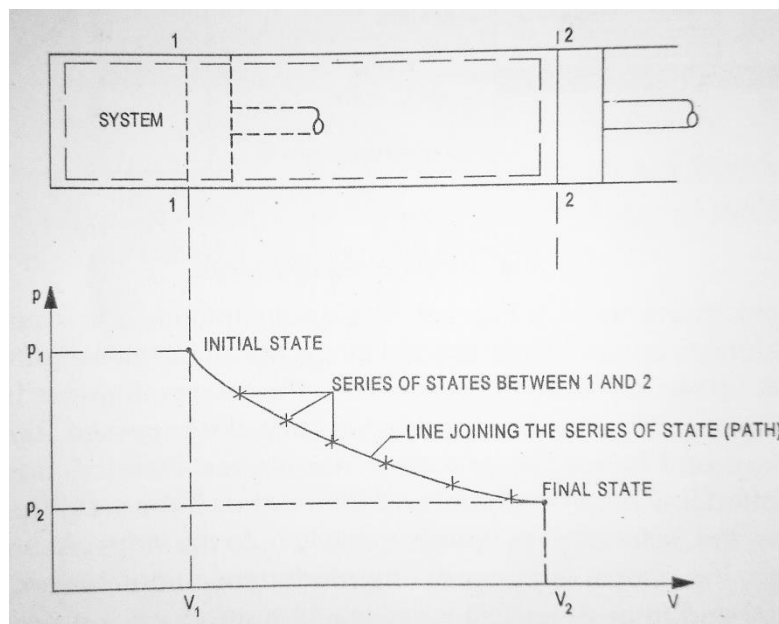

Thermodynamic Cycle: Thermodynamics cycle is a process in which initial and final conditions are same. A thermodynamic cycle is defined as a series of process such that the system returns to its initial state. Thus the series of processes (cycle process) in a cycle starts and ends at the

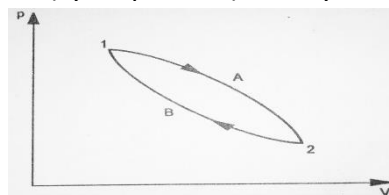

same state of a system.

(Figure illustrate the cycle comprising two processes A and B.)

Path function:

A Path function is a function whose value depends on the path followed by the thermodynamic process irrespective of the initial and final states of the process.

An example of path function is work done in a thermodynamic process.

- Work done in a thermodynamic process is dependent on the path followed by the process.
- A path function is an inexact or imperfect differential.

Point function:

A Point function (also known as state function) is a function whose value depends on the final and initial states of the thermodynamic process, irrespective of the path followed by the process.

- Example of point functions are density, enthalpy, internal energy, entropy etc.
- A point function is a property of the system or we can say all the properties of the system are point functions.
- Point functions are exact or perfect differential.

Note: Since a point function is only dependent on the initial or final state of the system, hence in a cyclic process value of a thermodynamic function is zero, or change in thermodynamic property is zero.

Difference between point function and path function:

Sr. no.	Point Function	Path Function
1	Its values are based on the state of the system (i.e. pressure, volume, temperature etc.)	Its values are based on how that particular thermodynamic state is achieved.
2	No matter by which process the state is obtained, its values will always remain the same.	Different processes to obtain a particular state will give us different values.

3	Only initial and final states of the process are sufficient	We need to know exact path followed by the process
4	Its values are independent of the path followed	Its values are dependent on the path followed
5	It is an exact or perfect differential	It is an inexact or imperfect differential.
6	Its cyclic integral is always zero	Its cyclic integral may or may not be zero
7	It is property of the system	It is not the property of the system
8	Its examples are density, enthalpy, internal energy, entropy etc	Its examples are Heat, work etc.

Thermodynamic equilibrium:

The system is said to be thermodynamic equilibrium when there is no spontaneous change in any macroscopic property is observed, as the system is isolated from its surroundings is known as thermodynamic Equilibrium.

When the property of a system is defined, it is understood that the system is in equilibrium.

- If a system is in thermal equilibrium, the temperature will be same throughout the system.
- If a system is in mechanical equilibrium, there is no tendency for the pressure to change. In a single phase system, if the concentration is uniform and there is no tendency for mass transfer or diffusion, the system is said to be in chemical equilibrium.

Thermodynamics Equilibrium

Thermal Equilibrium - The temperature of the system does not change with time and has same value at all points of the system.

Mechanical Equilibrium - There are no unbalanced forces within the system or between the surroundings. The pressure in the system is same at all points and does not change with respect to time.

Chemical Equilibrium - No chemical reaction takes place in the system and the chemical composition which is same throughout the system does not vary with time.

The following three types of equilibrium states must be achieved is called thermodynamics equilibrium.

Quasi-static process:

When a process proceeds in such a manner that the system remains infinitesimally close to an equilibrium state at all times: Quasi-static or Quasi-equilibrium process

- The process proceeds slow enough to allow the system to adjust itself internally so that properties in one part of the system do not change any faster than those at other parts.

Engineers are interested in quasi-static processes because – they are easy to analyse – work-producing devices deliver maximum work when they operate on quasi-static processes

- Quasi-static processes serve as standards to which actual processes can be compared.

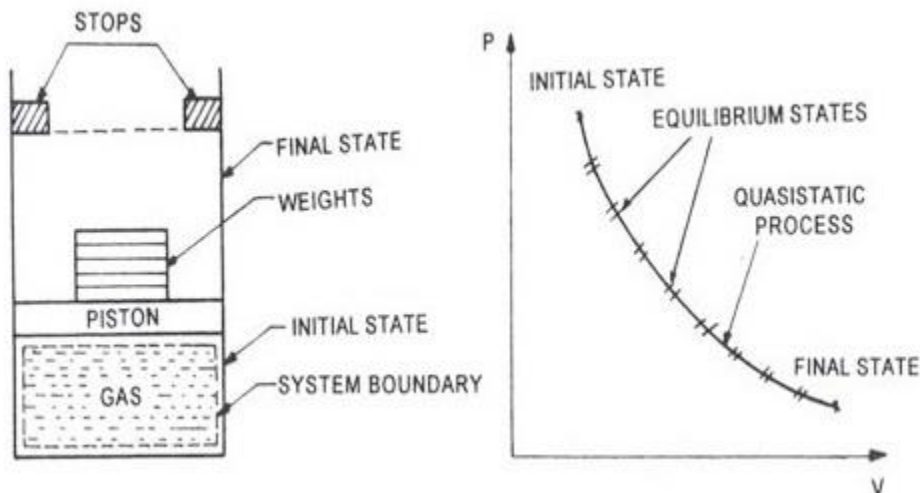

(Fig. Quasi-static process)

- The quasi-static or quasi-equilibrium process is also known as reversible process. A process which can be reversed in direction and the system retraces the same equilibrium states is known as reversible process.

Energy:

Energy possesses the ability to produce a dynamic, vital effect. Energy exists in various forms. e.g. mechanical, thermal, electrical etc. One form of energy can transform to other by suitable arrangements.

SOURCES OF ENERGY:

The various sources of energy are:

- Fuels- 1. Solids-Coal,Coke, Anthracite etc.
2. Liquids-Petroleum and its derivatives
3. Gases-Natural gas, blast furnace gas etc
- Energy stored in water
- Nuclear energy
- Wind energy
- Solar energy
- Tidal energy
- Geothermal energy
- Thermoelectric power

Power:

Any Physical unit of energy when divided by a unit of time automatically becomes a unit of power. Power can be defined as rate of flow of energy and can state that a power plant is a unit built for production and delivery of flow of mechanical and electrical energy. With the advancement of technology the power consumption is rising steadily.

This necessitates that in addition to the existing source of power such as coal, water, petroleum etc. other source of energy should be searched out and new and more efficient ways of producing energy should be decided.

Work:

The work is said to be done by a force when it acts on a body moving in the direction of force. Whenever a system interacts with its surroundings, it can exchange energy in two ways work and heat. In mechanics, work is defined as the product of the force and the displacement in the direction of the force.

Work done when a volume is increased or decreased Consider a gas in a container with a movable piston on top. If the gas expands, the piston moves out and work is done by the system on the surroundings.

To calculate the work done in moving the piston,

- we know that the, **force = pressure x area** and then,
work = pressure x area times distance or, **work = pressure x change in volume.**
So, **$W = \int p dV$**
- The differential work done (dW) associated with a differential displacement (dl) is given by
 $dW = F \cdot dl$
- For a piston cylinder assembly, **$dW = F dl = PA (dl) = P dV$**
- If the gas is allowed to expand reversibly from the initial pressure P to final pressure P , then the work done is given by **$W = \int p dV$**

The integral represents the area under the curve on a pressure versus volume diagram. Therefore the work depends on the path followed and work is a path function and hence not a property of the system.

- The above expression does not represent work in the case of an irreversible process.
- The thermodynamic definition of work is "Work is said to be done by a system on the surrounding if the sole effect external to the system could be reduced to the raising of a mass through a distance".

The integral expression gives the exact area under the curve which is equal to the work.

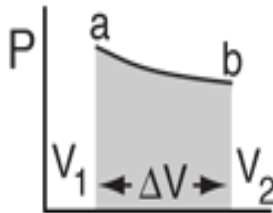
$$W = \int_{V_1}^{V_2} P dV$$

Heat:

Heat is the mode of energy transfer which takes place by virtue of temperature difference. The direction of spontaneous heat transfer is always from higher temperature to lower temperature. The mode of heat transfer may be in conduction, convection and radiation.

Heat like work, is energy in transit and it can be identified only at the boundary of the system.

- Heat is not stored in the body but energy is stored in the body.
- Heat, like work is not a property of the system and hence it is not an exact differential.
- Thus heat is also a path function and not point function.

Comparison of heat and work:

Comparison of Heat & work:

<u>Heat</u>	<u>WORK</u>
← Path function →	← Path function →
← Boundary phenomena →	← Boundary phenomena →
← inexact differential →	← inexact differential →
← Energy in transit →	← Energy in transit →
← Not a Property of System →	← Not a Property of System →
Low Grade Energy	High Grade energy

(imp)

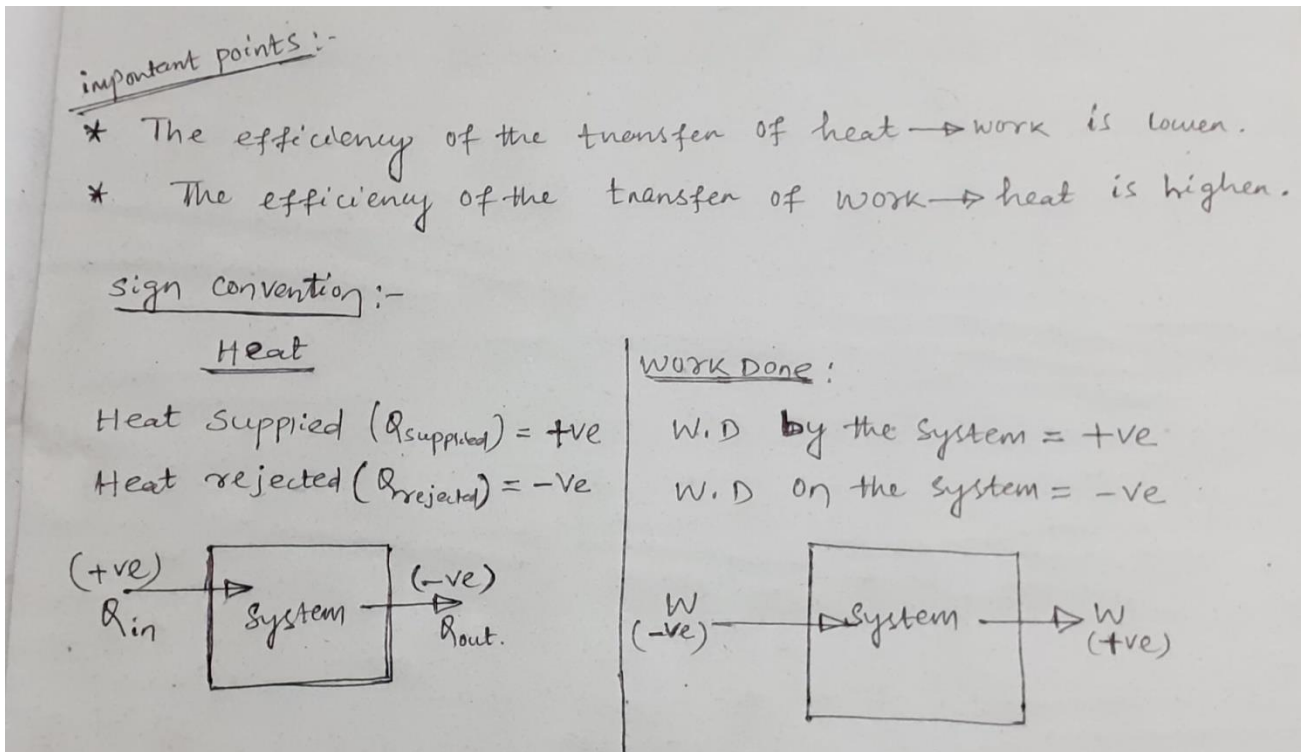

Mechanical equivalent of Heat:

There is a simple relation between mechanical work done on a system and heat generated in it. **James Prescott Joule** first experimentally found that the heat produced in a system is directly proportional to the mechanical work done on it.

He also calculated the constant of proportionality through a unique experiment, which we will also describe in this article. The constant is popularly known as **Mechanical Equivalent of Heat**. After the name of **James Prescott Joule**, the constant is also often known as **Joule's Mechanical Equivalent of Heat** or simply **Joule's Constant**. We denote it with the capital English letter J.

If W is the work done on a system and Q is the quantity of heat produced due to this work, then

$$\begin{aligned}
 W &\propto Q \\
 \Rightarrow W &= JQ \\
 \Rightarrow J &= \frac{W}{Q}
 \end{aligned}$$

After, this experiment, by putting all known values of

$$J = 4.186 \text{ kJ/kcal}$$

Here, in this experiment, the potential energy of the falling mass is converted into the kinetic energy and finally to the heat energy.

Displacement work:

Consider a piston cylinder arrangement as given in the Figure 2.4. If the pressure of the fluid is greater than that of the surroundings, there will be an unbalanced force on the face of the piston. Hence, the piston will move towards right.

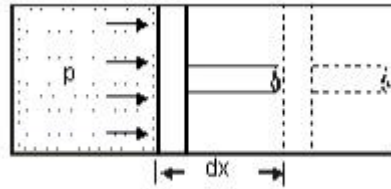

Figure 2.4 Displacement work

$$\begin{aligned}\text{Force acting on the piston} &= \text{Pressure} \times \text{Area} \\ &= p \cdot A\end{aligned}$$

$$\begin{aligned}\text{Work done} &= \text{Force} \times \text{distance} \\ &= pA \times dx \\ &= p \cdot dV\end{aligned}$$

Where, dV = change in volume.

This work is known as displacement work or pdV work corresponding to the elemental displacement dx . To obtain the total work done in a process, this elemental work must be added from the initial state to the final state.

Chapter-2

Laws of thermodynamics

The Zeroth Law of Thermodynamics:

The Zeroth law was first formulated and labeled by R.H. Fowler in 1931.

The Zeroth law of thermodynamics states that if two bodies are individually in equilibrium with a separate third body, then the first two bodies are also in thermal equilibrium with each other.

If two bodies are in thermal equilibrium with a third body, they are also in thermal equilibrium with each other.

- This obvious fact cannot be concluded from the other laws of thermodynamics, and it serves as a basis of temperature measurement.
- By replacing the third body with a thermometer, the zeroth law can be restated two bodies are in thermal equilibrium if both have the same temperature reading even if they are not in contact.

$$T_A = T_B, \text{ Also}$$

$$T_B = T_C,$$

$$\text{Therefore, } T_A = T_B = T_C$$

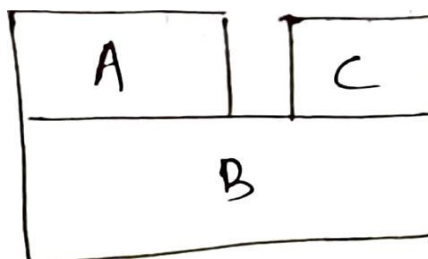

(Thermal equilibrium of three bodies)

First law of Thermodynamics:

- The first law of thermodynamics is the thermodynamic expression of the conservation of energy.
- This law most simply stated by saying that “energy can not be created or destroyed” or that “the energy of the universe is constant”.
- This law can be stated for a system (control mass) undergoing a cycle or for a change of state of a system. Stated for a system undergoing a cycle, the cyclic integral of the work is proportional to the cyclic integral of the heat.
- The important thing to remember is that the first law states that the energy is conserved always.

Mathematically stated,

for a control mass undergoing a cyclic process such as in Joule’s experiment and for consistent set of units ,

$$\int dQ \text{ from system} = \int dW \text{ on system}$$
$$\text{Or, } \int dQ \text{ from system} - \int dW \text{ on system} = 0$$

Limitations of first law of thermodynamics:

1. Heat is a path function;

Suppose a system is taken from state 1 to state 2 by the path 1-a-2 and is restored to the initial state by the path 2-b-1, then the system has undergone a cyclic process 1-a-2-b-1.

If the system is restored to the initial state by path 2-c-1, then the system has undergone the cyclic change 1-a-2-c-1.

Let us apply the first law of thermodynamics to the cyclic processes 1-a-2- b-1 and 1-a-2-c-1 to obtain

$$\int_{1-a-2} dQ + \int_{2-b-1} dQ - \int_{1-a-2} dW - \int_{2-b-1} dW = 0 \quad \int_{1-a-2} dQ + \int_{2-c-1} dQ - \int_{1-a-2} dW - \int_{2-c-1} dW = 0$$

Subtracting, we get

$$\int_{2-b-1} dQ - \int_{2-c-1} dQ - (\int_{2-b-1} dW - \int_{2-c-1} dW) = 0$$

We know that the work is a path function and hence the term in the bracket is non-zero.

$$\text{Hence we find } \int_{2-b-1} dQ = \int_{2-c-1} dQ$$

That is heat is also a path function.

2. Energy is a property of the system.;

By rearranging we can have $\int_{2-b-1} (dQ - dW) = \int_{2-c-1} (dQ - dW)$

It shows that the integral is the same for the paths 2-b-1 and 2-c-1, connecting the states 2 and state 1. That is, the quantity $\int (dQ - dW)$ does not depend on the path followed by a system, but depends only on the initial and the final states of the system.

That is $\int (dQ - dW)$ is an exact differential of a property.

This property is called energy (E). It is given by $dE = dQ - dW$ $E = KE + PE + U$

where U is the internal energy.

$$\text{Therefore, } dE = d(KE) + d(PE) + dU = dQ - dW$$

Quite often in many situations the KE or PE changes are negligible.

$$dU = dQ - dW$$

An isolated system does not exchange energy with the surroundings in the form of work as well as heat.

Hence $dQ = 0$ and $dW = 0$.

Then the first law of thermodynamics reduces to $dE = 0$ or $E_2 = E_1$ that is energy of an isolated system remains constant.

Perpetual Motion Machine of the first kind :

PMM-I is an imaginary device which delivers work continuously without absorbing energy from the surroundings is called a Perpetual Motion machine of the first kind.

Since the device has to deliver work continuously, it has to operate on a cycle.

If such a device does not absorb energy from its surroundings $\int dQ = 0$.

From the first law, it can be observed that $\int dW = 0$, if $\int dQ = 0$.

Therefore such a device is impossible from first law of thermodynamics.

Control-Volume Analysis:

Control volume is a volume in space of special interest for particular analysis.

The surface of the control volume is referred as a control surface and is a closed surface. The surface is defined with relative to a coordinate system that may be fixed, moving or rotating.

Mass, heat and work can cross the control surface and mass and properties can change with time within the control volume.

Examples: turbines, compressors, nozzle, diffuser, pumps, heat exchanger, reactors, a thrustproducing device, and combinations of these.

Steady flow process;

A flow process is the one in which a fluid enters the system and then leaves it after a work interaction.

The mass flow rate and energy flow rate across the system boundary are constant.

Important terms

Flow work – whenever a certain amount of mass enters a system, an amount of

work is required to push the mass into the system and out of it to maintain the continuity of flow.

i.e. Flow work = PV

Control Volume

For computation of mass and energy notes during a flow process, it is convenient to focus attention upon a certain fixed region in space called control volume.

Control surface

The boundary line defining the control volume is called control surface.

Stored energy of a system in a flow process:

During a steady state flow, there is neither any accumulation of mass nor energy.

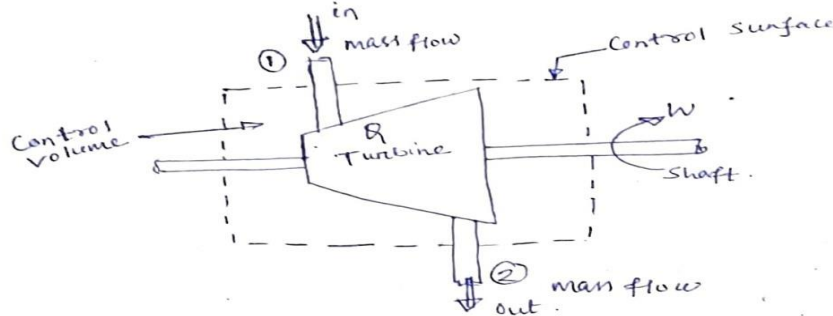

- The broken line represents the surface of the control volume which is known as Control Surface.
- Most of the engineering devices are open systems such as Turbines, Pumps, Compressor, Nozzle, Diffuser, etc.

Steady Flow Systems:-

- Steady flow means that the rates of flow of mass and energy across the control surface are constant.
- There is no accumulation of mass or energy within the control volume and the properties at any location within the control volume are steady with time.

Let us assume:

h = Specific enthalpy → Heat content of the system.

u = Specific internal energy.

$P \cdot v$ = flow work

C = Velocity

Z = Datum head

$K.E$ = Specific kinetic energy

$P.E$ = Specific potential energy

Q = Heat transfer

W = Work transfer

$$h = u + p \cdot v$$

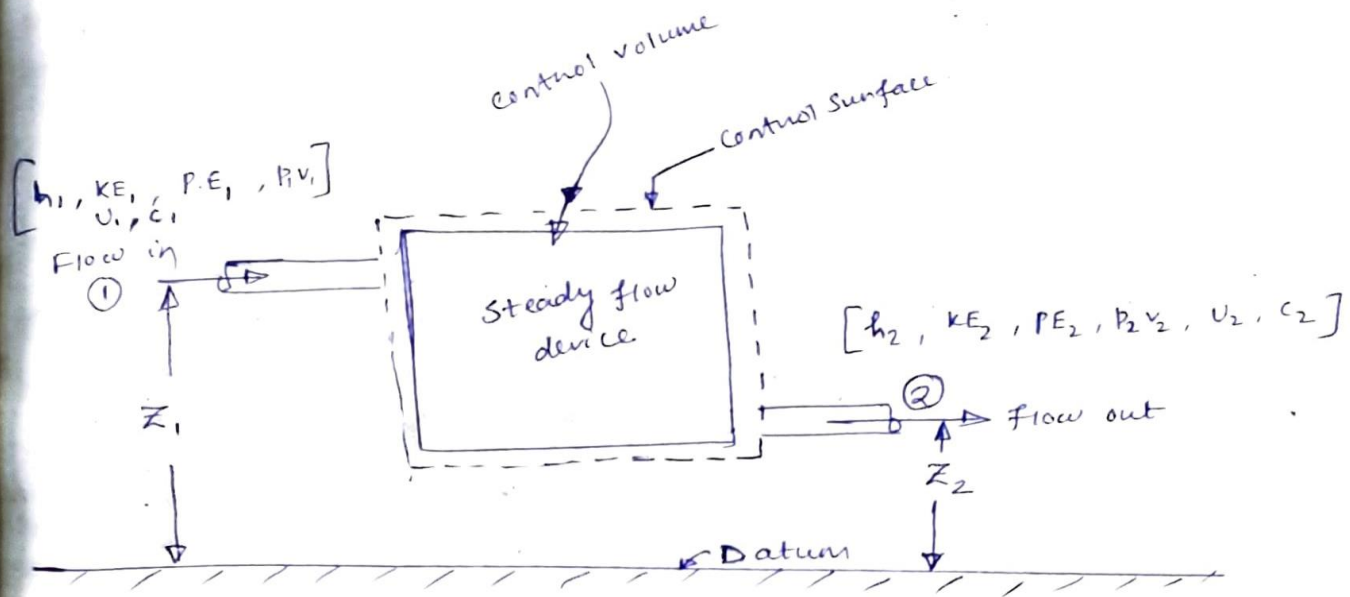

(fig: steady flow process)

Apply energy conservation Principle :

$$[U_1 + P_1 V_1 + KE_1 + PE_1 + Q] = [U_2 + P_2 V_2 + KE_2 + PE_2 + W]$$

$$\Rightarrow h_1 + KE_1 + PE_1 + Q = h_2 + KE_2 + PE_2 + W$$

$$\rightarrow h_1 + \frac{c_1^2}{2} + gz_1 + Q = h_2 + \frac{c_2^2}{2} + gz_2 + W$$

putting Q & W in per mass rate.

$$h_1 + \frac{c_1^2}{2} + gz_1 + \frac{dQ}{dm} = h_2 + \frac{c_2^2}{2} + gz_2 + \frac{dW}{dm}$$

we know, $Q = \frac{\dot{Q}}{\dot{m}}$ and $W_{cv} = \frac{\dot{W}}{\dot{m}}$
 \hookrightarrow Control surface work

$$h_1 + \frac{c_1^2}{2} + gz_1 + Q = h_2 + \frac{c_2^2}{2} + gz_2 + W_{cv} \quad \text{--- (1)}$$

\hookrightarrow S.F.E.E for unit mass transfer (m/\dot{m})

If we consider total mass transfer ;

$$\dot{m} \left[h_1 + \frac{c_1^2}{2} + gz_1 \right] + \dot{Q} = \dot{m} \left[h_2 + \frac{c_2^2}{2} + gz_2 \right] + \dot{W}_{cv} \quad \text{--- (2)}$$

\hookrightarrow S.F.E.E for unit time.

③ Turbine:-

It is a work producing device in which energy transferred from working fluid to the rotor.

In the case of turbine, expansion of the working fluid is takes place.

i.e work is done by the system.

Assumption:-

- i) Neglecting kinetic energy changes.
- ii) " potential energy changes.
- iii) Neglecting heat.

$$h_1 + KE_1 + PE_1 + Q = h_2 + KE_2 + PE_2 + W$$

$$\boxed{W_T = h_1 - h_2}$$

④ Compressor and pump:-

Both are work absorbing device, in which energy is transferred from rotor to working fluid. ⑤

⇒ Compressor, is generally used to handle the gaseous phase of the working fluid.

⇒ Pump, is generally used to handle the ~~non~~ liquid phase of the working fluid.

- Pump is generally used to increase the pressure of working liquid.
- Compressor is used for increasing the pressure and temperature of gaseous working substance.

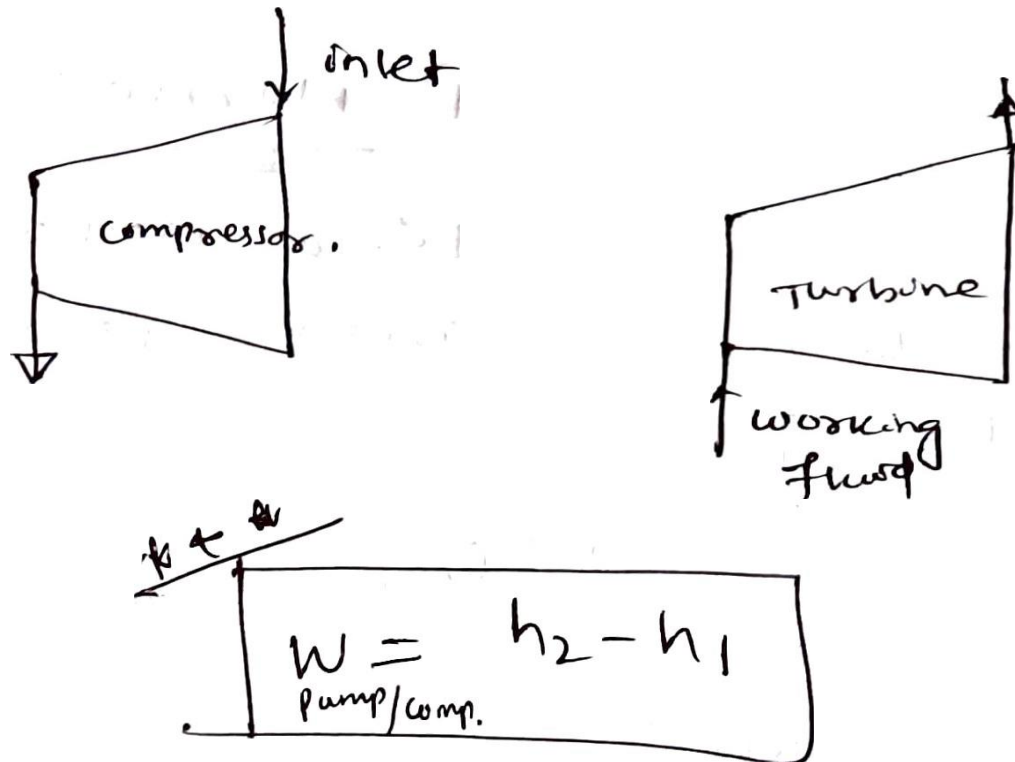

- A compressor compresses air or a gas by harnessing external work fed from a prime mover. The increase in the gas pressure is accompanied by the temperature rise.
- A steam turbine receives a superheated, high pressure steam that experiences its enthalpy drop as the steam passes over the turbine blades.

This enthalpy drop is converted into the kinetic energy of rotation of the blades mounted on the turbine drum.

The turbine is well insulated which gives rise to the maximum work output. The turbine is well insulated. $Q = 0$

Steam velocity at the turbine input = the steam velocity at the output.

Second law of Thermodynamics:

Limitation of first law:

There are two basic limitations of the first law of thermodynamics

- First law does not differentiate between heat and work. It assumes complete inter-convertibility of the two. Though work being a high grade energy can be fully converted into heat but heat cannot be completely converted to work.
- It does not permit us to know the direction of energy transfer. We cannot ascertain whether heat will flow from a higher temperature body to a lower temperature body vice versa.

Thermal Reservoir;

A thermal reservoir is a heat source or heat sink that remains at a constant temperature, regardless of energy interaction.

Otherwise a thermal energy reservoir (TER) is a large system body of infinite heat capacity which is capable of absorbing or rejecting a finite amount of heat without any changes in its thermodynamic coordinates.

The high temperature reservoir (T_H) that supplies heat is a **source**.

Sink – Low temperature reservoir (T_L) to which heat is rejected.

Example; Ocean water and atmospheric air are two good examples.

Statement of second law of the thermodynamics:

1. Kelvin Planck statement
2. Clausius statement

* Kelvin-planck's Statement! -

"It is impossible to construct a device which operating on a cycle produces work continuously while interacting with single thermal reservoir".

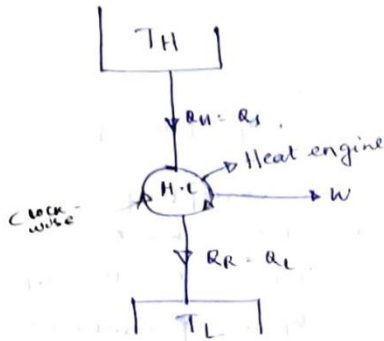

$$\eta = \frac{o/p}{i/p} = \frac{W_{net}}{Q_S} = \frac{Q_{net}}{Q_S} = 1 - \frac{Q_R}{Q_S}$$

$$\eta = 1 - \frac{Q_R}{Q_S}$$

Thermodynamic temp. scale or Kelvin temp. scale

i.e. $Q \propto T$.

$$\frac{Q_R}{Q_S} = \frac{T_R}{T_S} = \frac{T_L}{T_H}$$

$$\eta = 1 - \frac{T_L}{T_H}$$

Note:- Kelvin planck provides the concept of work producing device i.e. Heat engine.

Heat engine:-

A heat engine may be defined as a device, which operates in a thermodynamic cycle, converts heat energy into useful work and rejects the remaining heat to sink.

⊛ Heat engine is a work producing device. [$+W_{net}$]

⊛ Clausius statement:- "It is impossible to construct a device which operating in a cycle transfer heat from low temp. to high temp. without consuming any other form of energy."

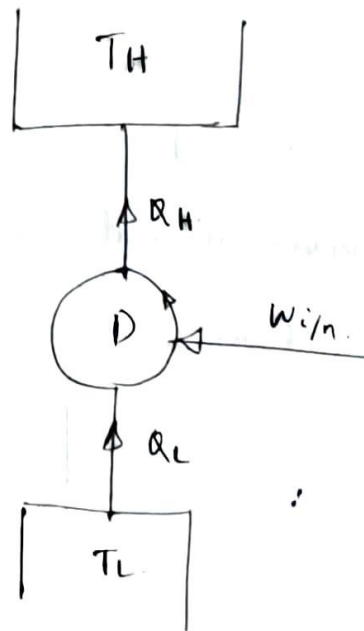
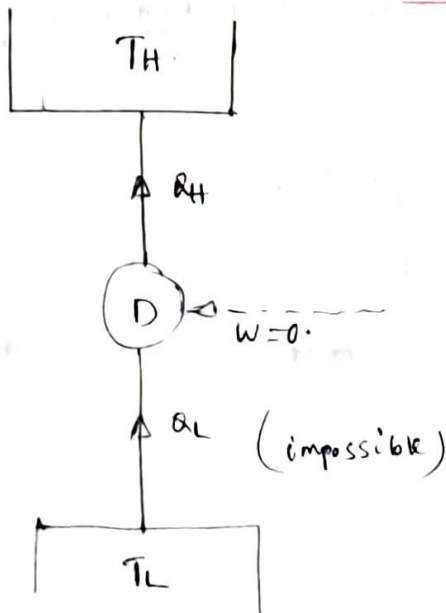

Heat pump:

A heat pump is a reversed heat engine. It receives heat from a low temperature reservoir source and rejects it to high temperature reservoir (sink) for which an external work which is supplied to the pump.

Refrigerator:

A refrigerator is similar to a heat pump. It operates as a reversed heat engine. Its duty is to extract heat as much as possible from the cold body and deliver the same to high temperature body.

Coefficient of performance (COP)/ Energy performance ratio (EPR):

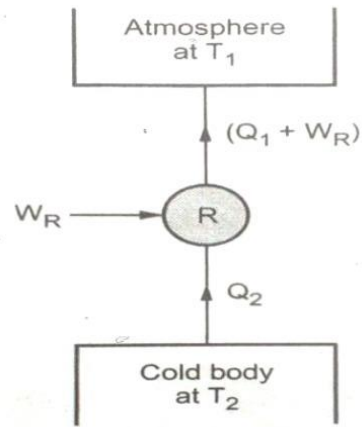
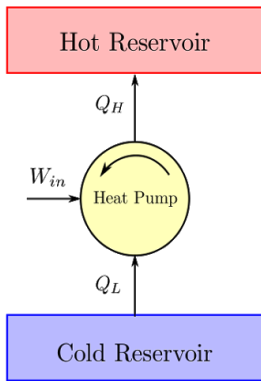

Figure: Refrigerator

Fig. (heat pump and refrigerator)

$$\text{COP} = \frac{\text{Desired effect}}{\text{Work input}}$$

$$\begin{aligned} (\text{COP})_{\text{HP}} &= \frac{Q_H}{W} \\ &= Q_H / (Q_H - Q_L) = T_1 / (T_1 - T_2) \end{aligned}$$

$$(\text{C.O.P})_R = \frac{D.E}{W_{in}} =$$

$$(\text{C.O.P})_R = \frac{T_L}{T_H - T_L}$$

Comparison of performance of Heat engine, Heat pump and Refrigerator:-

$$\eta_{\text{H.E}} = 1 - \frac{T_L}{T_H} = \frac{T_H - T_L}{T_H} \quad \text{--- (1)}$$

$$(\text{COP})_{\text{HP}} = \frac{T_H}{T_H - T_L} = \frac{1}{\eta_{\text{H.E}}} \quad \text{--- (2)}$$

Also; $(\text{COP})_{\text{HP}} = 1 + (\text{COP})_R$

$$\therefore (\text{COP})_{\text{HP}} = 1 + (\text{COP})_R = \frac{1}{\eta_{\text{H.E}}}$$

imp only applicable for same temp. limit for all.

Numerical on efficiency of H.E, COP of heat pump and refrigerator:

Numericals:-

- ①. What will be the efficiency of heat engine operating with a hot reservoir of furnace gases at 1700°C and cooling water available is at 15°C .

Ans:- _____

- ②. A domestic food refrigerator maintains a temperature of -10°C . The ambient air temperature is 40°C . If heat removed from the freezer is at the rate of 2.5 kJ/s , determine the least power necessary to ~~power~~ this.
- ③. If the efficiency of Reversible heat engine is 40% . Then what will be the C.O.P of heat pump and Refrigerator.

Chapter-3

Properties processes of perfect gas:

Introduction:

Gases:

- In contrast, changing the pressure or temperature of a gas will have an easily observable effect on the volume of that gas. For an **ideal gas** (no intermolecular interactions and no molecular volume) n appropriate equation of state would be: $V(T,P,n) = (nRT)/P$.
- There are many equations of state describing **real gases**. These equations take in consideration molecular volume and interactions. The most well-known such equations is probably the Van der Waals equation.

Ideal and real gases:

- An ideal gas is one which follows the ideal gas equation of state, namely

$$PV = m.R.T = n .R_u .T$$

Where, R= gas constant or characteristics gas constant

n = No. of moles

R_u = universal gas constant

The universal gas constant (R_u) has a value of 8.314 J/mol K or kJ/kmol K and is related to the specific gas constant by the relation

$$R_u = (R / M)$$

- The ideal gas equation of state can be derived from the kinetic theory of gases where the following assumptions are made:
 1. The molecules are independent of each other. In other words, there are no attractive forces between the molecules.
 2. The molecules do not occupy any volume. That is the volume occupied by the molecules is quite negligible compared to the volume available for motion of the molecules.

The internal energy of an ideal gas is a function of temperature only and is independent of pressure and volume.

$$\text{That is, } u = u(T) \quad (\partial u / \partial P)_T = 0, \quad (\partial u / \partial v)_T = 0$$

Difference between Real gas & Ideal gas

Sl. no	Real gas	Ideal gas
1	No gas follows all conditions of gas law under certain conditions of pressure & temperature but it approaches the ideal gas behavior. Hence it is called real gas.	A gas which obeys all the laws of gas under all conditions of temperature & pressure.
2	The relations derived from ideal gas may be applied to real gases under certain condition.	Ideal gas law is simple & hence simple relations are derived from it.
3	In certain condition real gas no more remain in gaseous phase but changes its state. So real gases under certain condition behaves like ideal gas.	O ₂ , N ₂ , H ₂ may be treated as ideal gas because ordinarily these are difficult to liquefy.

Ideal gas equation :-

The ideal gas equation is given as

$$PV = mRT \quad \text{--- (1)}$$

m = mass of the gas (kg).

R = characteristic gas constant in kJ/kg-K

or, $PV = n \cdot \bar{R} \cdot T \quad \text{--- (2)}$

n = number of kilomoles of the gas.

\bar{R} = universal gas constant.

$$= 8.314 \text{ kJ/k mol K}$$

} important

Note

* Value of R changes from gas to gas.

$$\text{For air, } R = 0.287 \text{ kJ/kg K (or) } 287 \text{ J/kg K}$$

⇒ Characteristic gas constant :- (R)

When the equation deals with mass, this is used. Its value changes from gas to gas.

$$\Rightarrow \text{For air, } R = 0.287 \text{ kJ/kg-K} \\ = 287 \text{ J/kg-K}$$

⇒ Universal gas constant (\bar{R}) :-

- When the equation deals with moles, it is in use.
- The value of \bar{R} is same for all the gasses.

$$\begin{aligned}\bar{R} &= 8.314 \text{ kJ/kg-mol-K} \\ &= 8314 \text{ J/kg-mol-K}\end{aligned}$$

* We know for ideal gas, $PV = mRT$

$$\frac{PV}{T} = mR = \text{constant} \quad (\text{as mass is always conserved}).$$

$$\therefore \frac{P_1 V_1}{T_1} = \frac{P_2 V_2}{T_2} = \text{constant} \quad (\text{for closed system}).$$

→ [Robert Boyle - 1662]

Boyle's law :- It states that, "the pressure exerted by a gas is inversely proportional to the volume occupied by it, when temperature kept constant".

$$\begin{aligned}P &\propto \frac{1}{V} \rightarrow \text{at } T = c \\ \Rightarrow P &= C \times \frac{1}{V} \\ \Rightarrow \boxed{PV = C}\end{aligned}$$

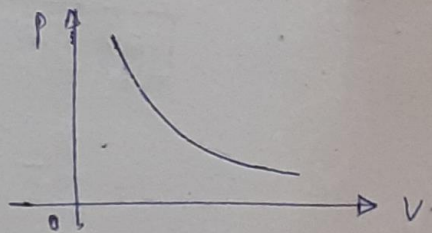

$$\begin{aligned}\Rightarrow P_1 V_1 &= P_2 V_2 = C \\ \text{at initial pt.} & \quad \text{final pt.}\end{aligned} \quad (\text{P-V diagram})$$

ex:- when a filled balloon is squeezed, the volume ↓ → P ↑

Charles's law :- [1780]

It states that the volume of an ideal gas is directly proportional to the absolute temperature at constant Pressure.

$$V \propto T \rightarrow \text{at } p = c$$

$$V = c \times T$$

$$\Rightarrow \frac{V}{T} = c$$

$$\frac{V_1}{T_1} = \frac{V_2}{T_2} = c \Rightarrow \frac{V_2}{V_1} = \frac{T_2}{T_1}$$

ex:- Overfill a tube on a hot day.

* By increasing the temperature the volume also increases.
Similarly, lowering the temp., the volume of the gas decreases.

And, At 0°C, the volume of the gas also increases by $\frac{1}{273}$ th of its ^{original} volume for a unit degree increase in temp.

Gay-Lussac's law :- [1808]

"The pressure exerted by a gas varies directly with the absolute temperature of the gas of a given mass and kept at a constant volume.

$$P \propto T \rightarrow \text{at } V = c$$

$$\Rightarrow \frac{P}{T} = c$$

$$\frac{P_1}{T_1} = \frac{P_2}{T_2} = c$$

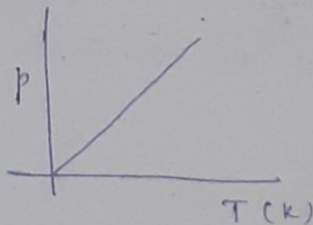

ex: ① Deodorant can / spray - paint can \Rightarrow heated \Rightarrow $T \uparrow \Rightarrow P \uparrow$.

[\therefore Warning labels \Rightarrow Containers must be kept away from the fire and stored in a cool environment]

② Pressure Cooker. ($T \uparrow \Rightarrow P \uparrow \Rightarrow$ Cook faster)

Avogadro's Law :-

"The total no. of atoms/molecules of a gas (i.e. amount of gaseous substance) is directly proportional to the volume occupied by the gas at constant temp. and pressure."

- Two dissimilar ideal gases occupying the same volume at a given temp. & pressure must contain an equal no. of molecules.

$$V \propto n \quad \text{at } p=c, T=\text{Constant}$$

$$\frac{V}{n} = c$$

$$\frac{V_1}{n_1} = \frac{V_2}{n_2}$$

Ideal gas equation, $PV = nRT$

$$\Rightarrow \frac{V}{n} = \frac{(RT)}{P}$$

$\underbrace{\hspace{2cm}}_{\rightarrow}$ is a constant value

since $T=c, P=c$

& $R=c$ for given gas.

$$\Rightarrow \frac{V}{n} = \text{constant}$$

ex:- The process of respiration, when humans inhale, the increase in the molar qty. of air in the lungs is accompanied by an increase in the volume of the lungs.

Dalton's law of Partial Pressure :-

"The total pressure exerted by a mixture of gases is equal to the sum of the partial pressures exerted by each individual gas in the mixture."

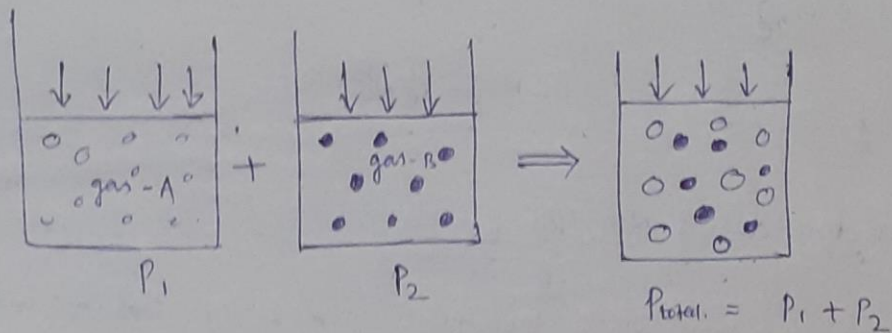

$$P_{total} = \sum_{i=1}^n P_i = P_1 + P_2 + \dots + P_n$$

* Specific heat of gas :-

The amount of heat required to raise the temp. of unit mass of substance through one degree centigrade, is known as specific heat.

$$\begin{aligned} \text{Specific heat, } Q &= m \cdot c \cdot \frac{dT}{\text{rise in temp. / temp. difference}} \\ &= C_p \rightarrow \text{for Constant Pressure} \\ &= C_v \rightarrow \text{for Constant volume} \end{aligned}$$

$$\ast 4.2 \text{ J/g}^\circ\text{C} \quad (1 \text{ cal/g.deg})$$

→ Heat can be transferred to gases either at constant pressure or at constant volume.

$$\text{Joule's law} \Rightarrow u = f(T)$$

$$C_p = C_v + R$$

$$\Rightarrow \boxed{C_p - C_v = R}$$

- Work done during Non-flow Process :-

T.D process which takes place in a closed system and has no fluid flow. i.e. flow work = 0.

$$\delta w = p dv$$

Hence total work, $W = \int_1^2 p dv$ Applicable
→ Closed system
→ Rev. (Quasi-stable)

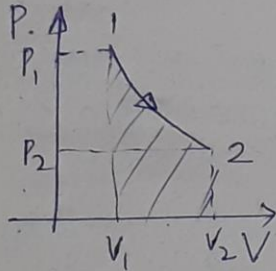

- The integration $\int p dv$ gives the work which is actually the area enclosed under the curve on P-v diagram.

Enthalpy:

When a process takes place at constant pressure, the heat absorbed or released is equal to the Enthalpy change. Enthalpy is sometimes known as "heat content."

Specific enthalpy, $h = u + Pv$

For an ideal gas $u = u(T)$ only

And $PV = mRT$ and hence $h = h(T)$ only.

Relation between two specific heats:

The two specific heats are related to each other.

$$h = u + Pv \text{ or } dh = du + d(Pv)$$

For an ideal gas, the above equation reduces to $dh = du + d(RT) = du + RdT$

$$\text{or } dh/dT = du/dT + R$$

$$\text{or } C_p = C_v + R \text{ or}$$

$$C_p - C_v = R$$

for an ideal gas. $\gamma = C_p / C_v$

$$\text{or } C_p = R/(\gamma-1) \text{ and } C_v = R\gamma/(\gamma-1)$$

Internal energy:

Internal energy U of a system or a body with well defined boundaries is the total of the kinetic energy due to the motion of molecules and the potential energy associated with the vibrational motion and electric energy of atoms within molecules. Internal energy also includes the energy in all the chemical bonds. From a microscopic point of view, the internal energy may be found in many different forms. For any material or repulsion between the individual molecules.

Internal Energy of a Closed System:

For a closed system the internal energy is essentially defined by

$$\Delta U = \Delta Q - \Delta W$$

Where

- ΔU is the change in internal energy of a system during a process
- ΔQ is the heat transfer in the system
- ΔW is the mechanical work on or by the system

If an energy exchange occurs because of temperature difference between a system and its surroundings, this energy appears as heat otherwise it appears as work. When a force acts on a system through a distance the energy is transferred as work. The above equation shows that energy is conserved.

Application of first law of thermodynamics to Non flow processes:

1. Isobaric process/ Constant pressure process :

An Isobaric process is a thermodynamic process taking place at constant pressure.

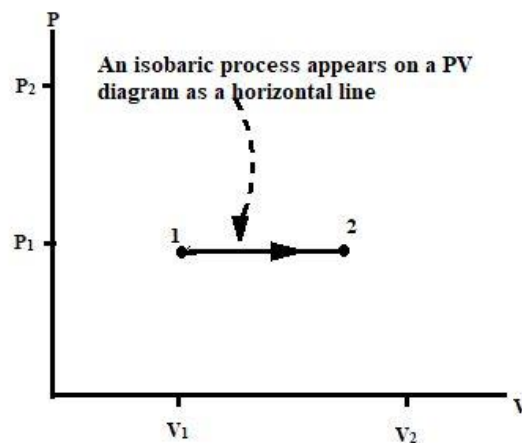

From first law of thermodynamics for process 1 - 2

$$\delta Q = dU + \delta W$$
$$\delta Q = dU + pdV$$

(Assumption: (1) closed system, (2) Quasistatic, (3) Stationary)

or

$$\delta Q = dU + d(PV)$$

(as P is constant)

$$\delta Q = d(U + PV)$$

but

$$(\delta Q)_P = dH$$

(by definition, $H = U + PV$)

$$(\delta Q)_P = mc_p dT$$

(by definition of c_p)

$$\therefore dH = mc_p dT$$

or

$$\Delta H = mc_p \Delta T$$

\therefore Heat transfer at constant pressure, $Q_p = \Delta H = mc_p \Delta T$

2. Isochoric process / Constant volume process :

A thermodynamic process taking place at constant volume is known as the isochoric process. It is also sometimes called as an isometric process or constant-volume process.

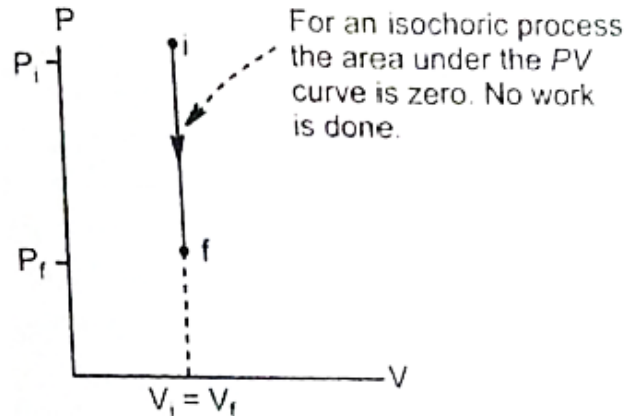

For constant volume process, $dV=0$ or $V_1=V_2$

Workdone, $W=PdV=0$

From first law of thermodynamics for the process 1 – 2
 $\delta Q = dU + \delta W$ {assuming stationary system}
 as its isochoric
 $\therefore \delta W = 0$
 i.e. $(\delta Q)_V = dU$
 but $(\delta Q)_V = m c_v dT$ {by deflection by c_v }
 $\therefore dU = m c_v dT$
 or Heat transfer at constant volume, $Q_V = \Delta U = m c_v \Delta T$

- The total heat supplied or rejected is also equal to the increase or decrease in the internal energy of the system.

3. Isothermal process / Constant temperature process :

An isothermal process is a thermodynamic process in which the temperature of a system remains constant.

The transfer of heat into or out of the system happens so slowly that thermal equilibrium is maintained. At a particular constant temperature, the change of a substance, object or system is known as Isothermal Process.

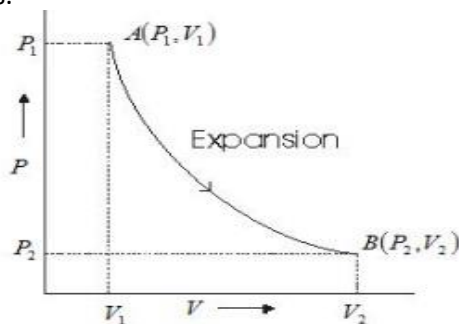

Consider pressure and volume of ideal gas changes from (P_1, V_1) to (P_2, V_2) .

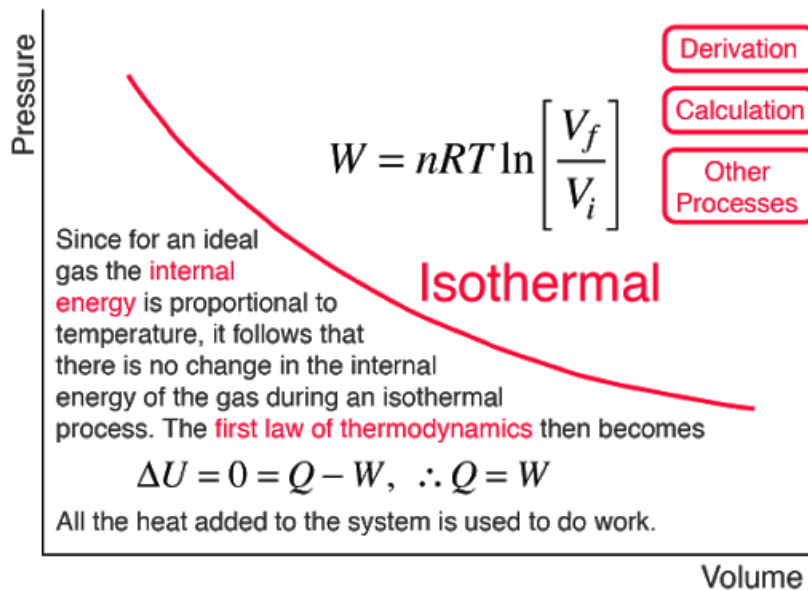

- When the gas expands from a high pressure to a low pressure there is a tendency for the temperature to fall. In an isothermal expansion heat must be added continuously in order to keep the temperature at its initial value (figure 3.5).
 - Similarly in an isothermal compression heat must be removed from the gas continuously during the process.
 - From first law of thermodynamics for process 1 – 2
- | | | |
|----------------------|----------------------------------|------------------------------|
| | $Q = \Delta U + W$ | (assuming stationary system) |
| as it is isothermal, | $\Delta U = C_v (T_2 - T_1) = 0$ | (for ideal gas) |
| \therefore | $Q = W$ | |
| or | $\delta Q = \delta W$ | |

4. Adiabatic process:

- An adiabatic process is defined as the thermodynamic process in which there is no exchange of heat from the system to its surrounding neither during expansion nor during compression.
- The system must be perfectly insulated from the surrounding.
- The process must be carried out quickly so that there is a sufficient amount of time for heat transfer to take place.

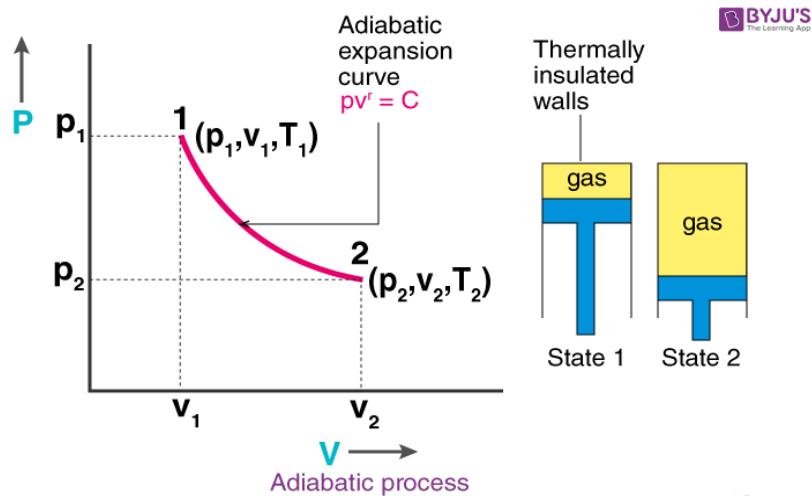

3.4.4 Reversible Adiabatic Process

- For an adiabatic process there is no heat transfer to or from the system during the process. It can either be reversible or irreversible.
- From first law of thermodynamics

$$\delta Q = dU + \delta W$$

here $\delta Q = 0$ (as adiabatic)

$\therefore \delta W = -dU$ or $W = U_1 - U_2$

But the above equations are valid for both reversible as well as irreversible adiabatic process.

- But for a reversible adiabatic, the governing equation for ideal gas is $PV^\gamma = C$

and
$$W = \frac{P_1 V_1 - P_2 V_2}{\gamma - 1}$$
 (derived earlier)

$\therefore U_1 - U_2 = W = \frac{P_1 V_1 - P_2 V_2}{\gamma - 1}$

$$= \frac{mR(T_1 - T_2)}{\gamma - 1}$$

$$\begin{aligned} W_{adia} &= \int_{V_1}^{V_2} P dV \\ &= \int_{V_1}^{V_2} KV^{-\gamma} dV \quad [P = KV^{-\gamma}] \\ &= K \int_{V_1}^{V_2} V^{-\gamma} dV \\ &= k \left[\frac{V^{1-\gamma}}{1-\gamma} \right]_{V_1}^{V_2} \\ &= \frac{k}{1-\gamma} [V_2^{1-\gamma} - V_1^{1-\gamma}] \\ &= \frac{1}{\gamma-1} [KV_1^{1-\gamma} - KV_2^{1-\gamma}] \end{aligned}$$

We know that

$$K = P_1 V_1^\gamma = P_2 V_2^\gamma$$

$$W_{adia} = \frac{1}{1-\gamma} [P_1 V_1^\gamma V_1^{1-\gamma} - P_2 V_2^\gamma V_2^{1-\gamma}]$$

$$W_{adia} = \frac{1}{\gamma-1} [P_1 V_1 - P_2 V_2]$$

5. Polytropic process:

During actual expansion and compression processes of gases, pressure and volume are often related by $PV^n = C$, where n (polytropic index) and C are constants. A process of this kind is called Polytropic process.

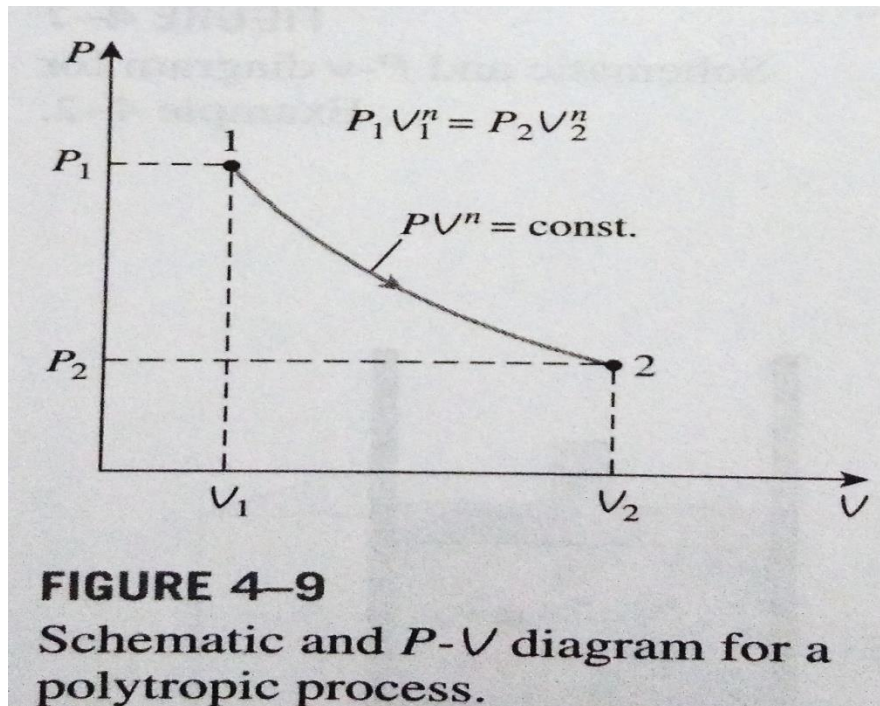

$PV^n = C$, the value of polytropic index (n) for different processes are;

$n = 0$, constant pressure process

$$w = P(v_2 - v_1)$$

$n = 1$, constant temperature process

$$w = q = RT \ln \frac{v_2}{v_1}$$

$n = \gamma$, reversible adiabatic process

$$w = \frac{P_1 v_1 - P_2 v_2}{\gamma - 1}$$

$n = \infty$, constant volume process

$$w = 0$$

Free expansion process:

- Free expansion process is expansion against vacuum. where total energy $E = U + KE$ and during internal energy is converted into kinetic energy. after all end of process final temperature will be equals to initial temperature.
- In free expansion process heat interaction from surrounding will be zero and integral work done will be zero.

$$dq = 0, dt = 0, dw = 0$$

Consider a properly insulated cylinder with a partition & stopper. Now place some gas on one side & evacuate other side. When you remove stopper this gas expands freely to the other side of cylinder.

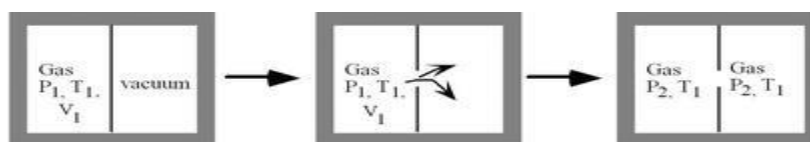

Throttling process:

The process in which a high pressure fluid is converted to low pressure by using a throttle valve is Throttling. In throttling process enthalpy remains constant , work done is 0.

- Another name of throttling process is wire drawing because the steam looks like a wire after certain extent .
- for ideal gas throttling process is isothermal.
- for real gases due to throttling the temp. may increase decrease or remain const.
- for steam due to throttling the temperature always drop.

Throttling devices

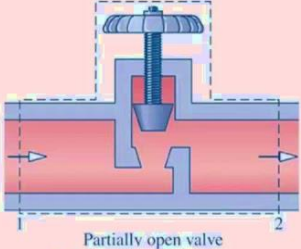

Partially open valve

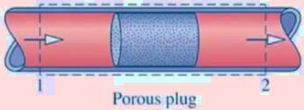

Porous plug

Flow restriction

- Slow flows, ΔKE effects can be neglected



Capillary tube expansion valve used to drop refrigerant pressure and temperature

Negligible heat transfer (small devices) $(\propto \text{surface area})$

$$\dot{m}(h_2 - h_1 + \frac{V_2^2 - V_1^2}{2}) = 0 \quad h_2 = h_1$$

Throttling is an isenthalpic process.

Fundamentally, non-quasiequilibrium.

A throttling process is a thermodynamic process, in which the enthalpy of the gas or medium remains constant ($h = \text{const}$).

In fact, the **throttling process** is one of **isenthalpic processes**. During the throttling process no work is done by or on the system ($dW = 0$), and usually there is no heat transfer (adiabatic) from or into the system ($dQ = 0$).

Chapter-4

Internal combustion engine:

Heat engine:

A heat engine is a device which transforms the chemical energy of a fuel into thermal energy and uses this energy to produce mechanical work.

It is classified into two types-

- (a) External combustion engine
- (b) Internal combustion engine

External combustion engine: In this engine, the products of combustion of air and fuel transfer heat to a second fluid which is the working fluid of the cycle.

Examples:

- In the steam engine or a steam turbine plant, the heat of combustion is employed to generate steam which is used in a piston engine (reciprocating type engine) or a turbine (rotary type engine) for useful work.
- In a closed cycle gas turbine, the heat of combustion in an external furnace is transferred to gas, usually air which the working fluid of the cycle.

Internal combustion engine:

In this engine, the combustion of air and fuels take place inside the cylinder and are used as the direct motive force.

It can be classified into the following types:

1. According to the basic engine design-
 - Reciprocating engine (Use of cylinder piston arrangement)
 - Rotary engine (Use of turbine)
2. According to the type of fuel used-
 - Petrol engine
 - diesel engine
 - gas engine (CNG, LPG)
 - Alcohol engine (ethanol, methanol etc)
3. According to the number of strokes per cycle-
 - Four stroke and
 - Two stroke engine
4. According to the method of igniting the fuel-
 - Spark ignition engine
 - compression ignition engine
 - hot spot ignition engine
5. According to the working cycle-
 - Otto cycle (constant volume cycle) engine
 - diesel cycle (constant pressure cycle) engine
 - dual combustion cycle (semi diesel cycle) engine
6. According to the number of cylinder-
 - Single cylinder and
 - multi-cylinder engine

7. Method of cooling-

- water cooled, or
- air cooled

8. Speed of the engine-

- Slow speed,
- medium speed and
- high speed engine

9. Cylinder arrangement-

- Vertical,
- horizontal,
- inline,
- V-type,
- radial,
- opposed cylinder or piston engines.

Comparison between external combustion engine and internal combustion engine:

External combustion engine	Internal combustion engine
Combustion of air-fuel is outside the engine cylinder (in a boiler)	Combustion of air-fuel is inside the engine cylinder (in a boiler)
The engines are running smoothly and silently due to outside combustion	Very noisy operated engine
Higher ratio of weight and bulk to output due to presence of auxiliary apparatus like boiler and condenser. Hence it is heavy and cumbersome.	It is light and compact due to lower ratio of weight and bulk to output.
Working pressure and temperature inside the engine cylinder is low; hence ordinary alloys are used for the manufacture of engine cylinder and its parts.	Working pressure and temperature inside the engine cylinder is very much high; hence special alloys are used
It can use cheaper fuels including solid fuels	High grade fuels are used with proper filtration
Lower efficiency about 15-20%	Higher efficiency about 35-40%
Higher requirement of water for dissipation of energy through cooling system	Lesser requirement of water
High starting torque	IC engines are not self-starting

Main components of reciprocating IC engines:

Cylinder:

It is the main part of the engine inside which piston reciprocates to and fro. It should have high strength to withstand high pressure above 50 bar and temperature above 2000⁰ C.

The ordinary engine is made of cast iron and heavy duty engines are made of steel alloys or aluminum alloys. In the multi-cylinder engine, the cylinders are cast in one block known as cylinder block.

Cylinder head:

The top end of the cylinder is covered by cylinder head over which inlet and exhaust valve, spark plug or injectors are mounted. A copper or asbestos gasket is provided between the engine cylinder and cylinder head to make an air tight joint.

Piston:

Transmit the force exerted by the burning of charge to the connecting rod. Usually made of aluminium alloy which has good heat conducting property and greater strength at higher temperature.

Piston rings:

These are housed in the circumferential grooves provided on the outer surface of the piston and made of steel alloys which retain elastic properties even at high temperature.

2 types of piston rings-

- Compression rings: Compression ring is upper ring of the piston which provides air tight seal to prevent leakage of the burnt gases into the lower portion.
- oil rings: Oil ring is lower ring which provides effective seal to prevent leakage of the oil into the engine cylinder.

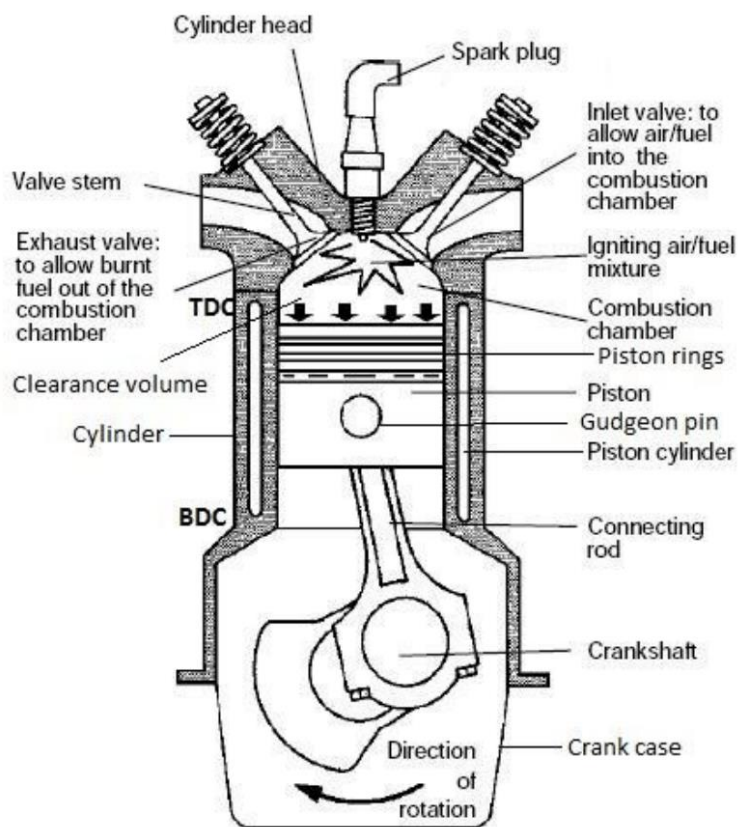

Fig.(Different parts of IC engine)

Connecting rod:

It converts reciprocating motion of the piston into circular motion of the crank shaft, in the working stroke. The smaller end of the connecting rod is connected with the piston by gudgeon pin and bigger end of the connecting rod is connected with the crank with crank pin. The special steel alloys or aluminium alloys are used for the manufacture of connecting rod.

Crankshaft:

It converts the reciprocating motion of the piston into the rotary motion with the help of connecting rod. The special steel alloys are used for the manufacturing of the crankshaft. It consists of eccentric portion called crank.

Crank case:

It houses cylinder and crankshaft of the IC engine and also serves as sump for the lubricating oil.

Flywheel:

It is big wheel mounted on the crankshaft, whose function is to maintain its speed constant. It is done by storing excess energy during the power stroke, which is returned during other stroke.

Terminology used in IC engine:

- Cylinder bore (D):
The nominal inner diameter of the working cylinder.
 - Piston area (A):
The area of circle of diameter equal to the cylinder bore.
 - Stroke (L):
The nominal distance through which a working piston moves between two successive reversals of its direction of motion.
 - Dead centre:
The position of the working piston and the moving parts which are mechanically connected to it at the moment when the direction of the piston motion is reversed (at either end point of the stroke).
(a) Bottom dead centre (BDC): Dead centre when the piston is nearest to the crankshaft.
(b) Top dead centre (TDC): Dead centre when the position is farthest from the crankshaft.
 - Displacement volume / swept volume (Vs):
Swept volume can be defined as the volume swept by the engine piston during one stroke. Swept volume is also the product of piston area and stroke.
The nominal volume generated by the working piston when travelling from the one dead centre to next one and given as,
$$V_s = A \times L$$
 - Clearance volume (Vc):
Clearance volume can be defined as the volume that remains in the cylinder when the engine piston is in the top centre position.
Clearance volume can also be defined as the difference between the total cylinder volume and the swept volume. The space covered by the clearance volume also forms the combustion chamber.
The nominal volume of the space on the combustion side of the piston at the top dead centre.
 - Cylinder volume (V):
Total volume of the cylinder. $V = V_s + V_c$
 - Compression ratio (r):
Compression ratio, in an internal-combustion engine, degree to which the fuel mixture is compressed before ignition. It is defined as the maximum volume of the combustion chamber divided by the volume with the piston in the full-compression position.
Compression ratio, $r = V_s / V_c$
- Piston speed:
The mean piston speed is the average speed of the piston in a reciprocating engine. It is a function of stroke and RPM. There is a factor of 2 in the equation to account for one stroke to occur in 1/2 of a crank revolution (or alternatively: two strokes per one crank revolution) and a '60' to convert seconds from minutes in the RPM term.

- **RPM(Revolution per minute):**
Revolutions per minute (abbreviated rpm, RPM, rev/min, r/min, or with the notation min^{-1}) is the number of turns in one minute. It is a unit of rotational speed or the frequency of rotation around a fixed axis.

Four stroke engine: -

Cycle of operation completed in four strokes of the piston or two revolution of the piston.

- Suction stroke (suction valve open, exhaust valve closed)-charge consisting of fresh air mixed with the fuel is drawn into the cylinder due to the vacuum pressure created by the movement of the piston from TDC to BDC.
- Compression stroke (both valves closed)-fresh charge is compressed into clearance volume by the return stroke of the piston and ignited by the spark for combustion. Hence pressure and temperature is increased due to the combustion of fuel
- Expansion stroke (both valves closed)-high pressure of the burnt gases force the piston towards BDC and hence power is obtained at the crankshaft.
- Exhaust stroke (exhaust valve open, suction valve closed)- burned gases expel out due to the movement of piston from BDC to TDC.

Four-stroke cycle

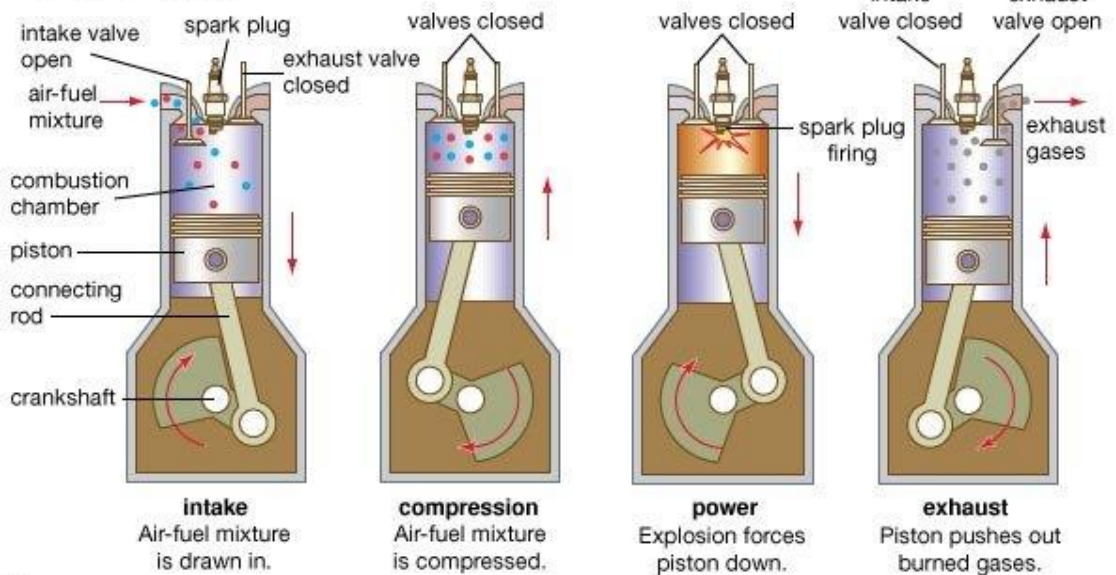
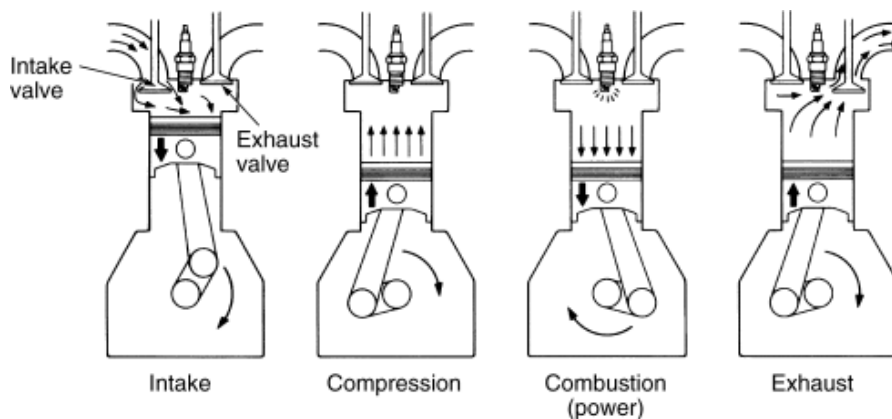

Fig. Cycle of operation in four stroke engine



Two stroke engine:

No piston stroke for suction and exhaust operations -

- Suction is accomplished by air compressed in crankcase or by a blower
- Induction of compressed air removes the products of combustion through exhaust ports
- Transfer port is there to supply the fresh charge into combustion chamber

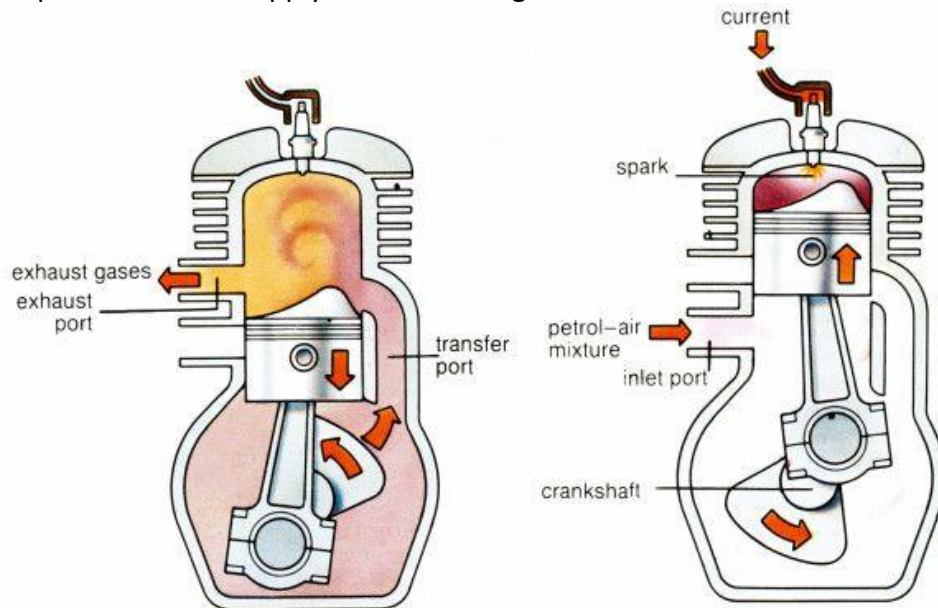

Fig. Cycle of operation in two stroke engine

- A two-stroke engine performs all the same steps, but in just two piston strokes. The simplest two-stroke engines do this by using the crankcase and the underside of the moving piston as a fresh charge pump. Such engines carry the official name "crankcase-scavenged two-strokes."
- As the two-stroke's piston rises on compression, its underside pulls a partial vacuum in the crankcase. An intake port of some kind (cylinder wall port, reed valve or rotary disc valve) opens, allowing air to rush into the crankcase through a carburetor.
- As the piston nears Top Dead Center, a spark fires the compressed mixture. As in a four-stroke, the mixture burns and its chemical energy becomes heat energy, raising the pressure of the burned mixture to hundreds of psi. This pressure drives the piston down the bore, rotating the crankshaft.
- As the piston continues down the bore, it begins to expose an exhaust port in the cylinder wall. As spent combustion gas rushes out through this port, the descending piston is simultaneously compressing the fuel-air mixture trapped beneath it in the crankcase.
- As the piston descends more, it begins to expose two or more fresh-charge ports, which are connected to the crankcase by short ducts. As pressure in the cylinder is now low and pressure in the crankcase higher, fresh charge from the crankcase rushes into the cylinder through the fresh-charge (or "transfer") ports. These ports are shaped and aimed to minimize direct loss of fresh charge to the exhaust port. Even in the best designs, there is some loss, but simplicity has its price! This process of filling the cylinder while also pushing leftover exhaust gas out the exhaust port is called "scavenging."
- While the piston is near Bottom Dead Center, mixture continues to move from the crankcase, up through the transfer ports, and into the cylinder.
- As the piston rises, it first covers the transfer ports, leaving only the exhaust port still open. If there were no way to stop it, much of the fresh charge would now be pumped out the exhaust.

- But there is a simple way to stop it—using exhaust pressure waves in the exhaust. If we shape and dimension the exhaust pipe right, a reflection of the original pressure pulse, generated as the exhaust port opened, will bounce back to the port just as fresh charge is being pumped out of it. This pressure wave stuffs the fresh charge back into the cylinder just as the rising piston covers the exhaust port

Comparison of Four-stroke and two-stroke engine:

Sl.no	Four-stroke engine	Two-stroke engine
1.	Four stroke of the piston and two revolution of crankshaft	Two stroke of the piston and one revolution of crankshaft
2.	One power stroke in every two revolution of crankshaft	One power stroke in each revolution of crankshaft
3.	Heavier flywheel due to non-uniform turning movement	Lighter flywheel due to more uniform turning movement
4.	Power produce is less	Theoretically power produce is twice than the four stroke engine for same size
5.	Heavy and bulky	Light and compact
6.	Lesser cooling and lubrication requirements	Greater cooling and lubrication requirements
7.	Lesser rate of wear and tear	Higher rate of wear and tear
8.	Contains valve and valve mechanism	Contains ports arrangement
9.	Higher initial cost	Cheaper initial cost
10.	Volumetric efficiency is more due to greater time of induction	Volumetric efficiency less due to lesser time of induction
11.	Thermal efficiency is high and also part load efficiency better	Thermal efficiency is low, part load efficiency lesser
12.	12. It is used where efficiency is important. Ex-cars, buses, trucks, tractors, industrial engines, aero planes, power generation etc.	It is used where low cost, compactness and light weight are important. Ex-lawn mowers, scooters, motor cycles, mopeds, propulsion ship etc.

Comparison of Petrol(SI) and Diesel (CI) engine:

Sl.no	Petrol(SI) engine	Diesel (CI) engine
1.	Working cycle is Otto cycle.	Working cycle is diesel cycle.
2.	Petrol or gasoline or high octane fuel is used.	Diesel or high cetane fuel is used.
3.	High self-ignition temperature.	Low self-ignition temperature
4.	Fuel and air introduced as a gaseous mixture in the suction stroke.	Fuel is injected directly into the combustion chamber at high pressure at the end of compression stroke.
5.	Carburettor used to provide the mixture. Throttle controls the quantity of mixture introduced.	Injector and high pressure pump used to supply of fuel. Quantity of fuel regulated in pump.
6.	Use of spark plug for ignition system	Self-ignition by the compression of air which increased the temperature required for combustion
7.	Compression ratio is 6 to 10.5	Compression ratio is 14 to 22

8.	Higher maximum RPM due to lower weight	Lower maximum RPM
9.	Maximum efficiency lower due to lower compression ratio	Higher maximum efficiency due to higher compression ratio
10.	Lighter	Heavier due to higher pressures

Chapter-5

Air standard cycle:

Introduction:

- Deal with systems that produce power in which the working fluid remains a gas throughout the cycle (in other words, there is no change in phase).
- Spark Ignition (gasoline) engines, Compression ignition (diesel) engines and conventional gas turbine engines (generally refer to as Internal Combustion engines or IC Engines) are some examples of engines that operate on gas cycles.
- Internal combustion engines: Combustion of fuel is non-cyclic process. Working fluid, air-fuel mixture undergoes permanent chemical change due to combustion Products are thrown out of the engine & Fresh charge is taken in.

Carnot cycle:

In 1824 Carnot suggested a particular cycle of operation for a CHPP which avoided all irreversibilities.

- It consisted of four processes, two isothermal and two adiabatic.
- The process take place between a heat source at temperature (T_H) and a heat sink at temperature (T_C).
- **The most efficient heat engine cycle is the Carnot cycle.**

Following are the four processes of the Carnot cycle:

- The first process is reversible isothermal gas expansion. In this process, the amount of heat absorbed by the ideal gas is Q_{in} from the heat source, which is at a temperature of T_H . The gas expands and does work on the surroundings.
- The second process is reversible adiabatic gas expansion. Here, the system is thermally insulated, and the gas continues to expand and work is done on the surroundings. Now the temperature is lower, T_L .
- The third process is reversible isothermal gas compression process. Here, the heat loss Q_{out} occurs when the surroundings do the work at temperature T_H .
- The last process is reversible adiabatic gas compression. Again the system is thermally insulated. The temperature again rises back to T_H as the surrounding continue to do their work on the gas.

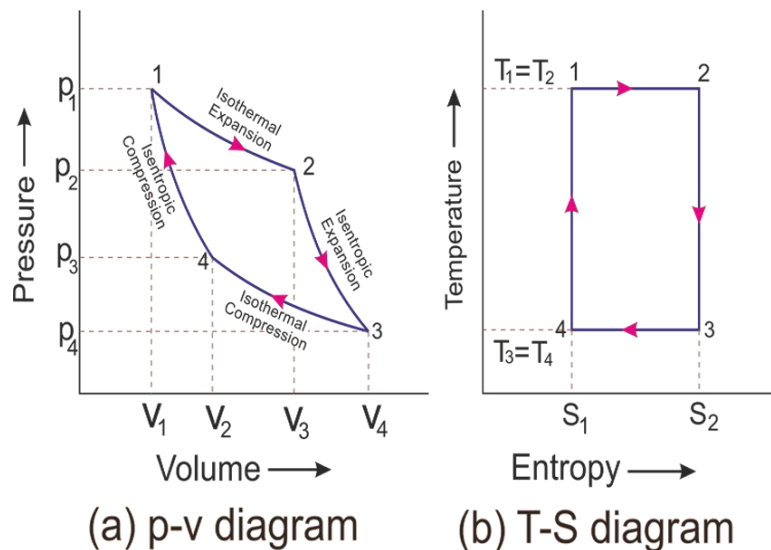

Thermal Efficiency = Workdone/Amount of heat supplied

Work done (W) = Heat supplied(Q_s) - Heat rejected(Q_R)

$$\text{Thermal } \eta = \frac{\text{Work done (W)}}{\text{Heat Supplied (Q}_s)} = \frac{\text{Heat Supplied} - \text{Heat Rejected}}{\text{Heat Supplied}}$$

$$\Rightarrow \eta = \frac{Q_s - Q_R}{Q_s}$$

$$\text{Heat Supplied 1-2; } Q_s = P_1 V_1 \log_e \left[\frac{V_2}{V_1} \right] = mRT_1 \log_e \left[\frac{V_2}{V_1} \right]$$

$$\text{Heat Rejected 3-4; } Q_R = P_3 V_3 \log_e \left[\frac{V_3}{V_4} \right] = mRT_3 \log_e \left[\frac{V_3}{V_4} \right]$$

$$\left[\because \frac{V_2}{V_1} = \frac{V_3}{V_4} \right] \text{ (or)}$$

$$\text{Compression ratio} = \frac{V_2}{V_1} = \frac{V_3}{V_4} = r$$

$$\eta_{th} = \frac{mRT_1 \log_e \left[\frac{V_2}{V_1} \right] - mRT_3 \log_e \left[\frac{V_3}{V_4} \right]}{mRT_1 \log_e \left[\frac{V_2}{V_1} \right]}$$

$$\left[\because \frac{V_2}{V_1} = \frac{V_3}{V_4} \right]$$

$$\boxed{\eta_{th} = \left[1 - \frac{T_3}{T_1} \right]}$$

So the efficiency of carnot cycle depends upon the temperature limits (T_H & T_L)

$$\eta = 1 - \frac{T_{cold}}{T_{hot}}$$

Otto cycle:

Otto cycle is the ideal cycle for spark ignition reciprocating engines.

- Named after Nikolaus A. Otto, who built a successful four-stroke engine in 1876 in Germany.
- Can be executed in two or four strokes.
- Four stroke: Intake, compression, power and exhaust stroke
- Two stroke: Compression and power strokes.

Otto cycle consists of four processes ,all the processes are internally reversible

- Isentropic compression (1-2)
- Isochoric (constant volume) heat addition (2-3)
- Isentropic expansion (3-4)
- Isochoric (constant volume) heat rejection (4-1)

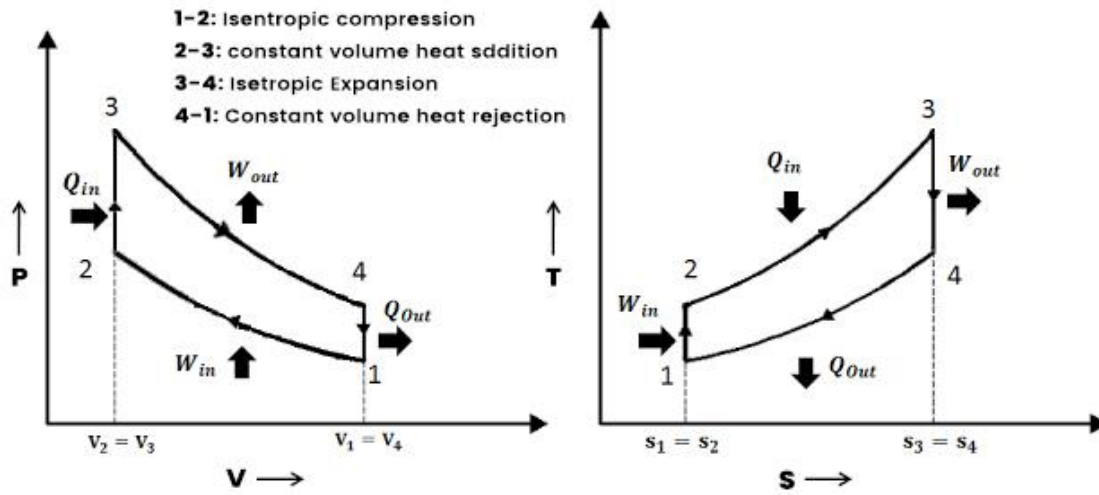

P-V and T-S Diagram of Otto Cycle

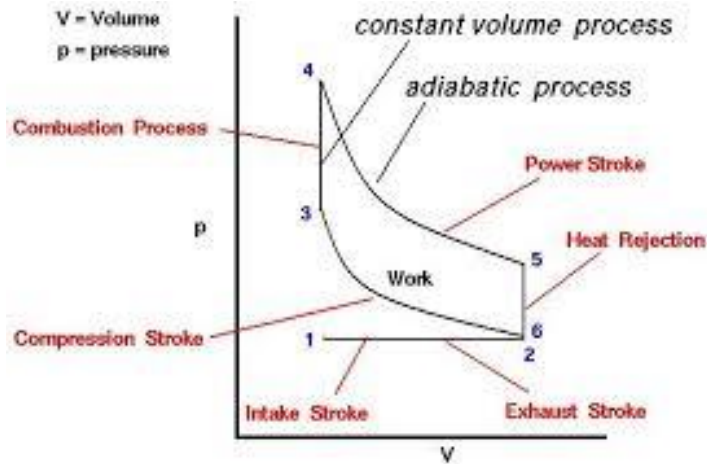

Heat supplied, $q_s = C_v(T_3 - T_2)$

Heat rejection, $q_R = C_v(T_4 - T_1)$

Compression ratio, $r_k = \frac{V_1}{V_2}$

Thermal efficiency, $\eta_{th} = \frac{q_s - q_R}{q_s} = \frac{C_v(T_3 - T_2) - C_v(T_4 - T_1)}{C_v(T_3 - T_2)} = 1 - \frac{T_4 - T_1}{T_3 - T_2}$

In process 1-2, adiabatic compression process,

$$\frac{T_2}{T_1} = \left(\frac{V_1}{V_2}\right)^{\gamma-1}$$

$$\Rightarrow T_2 = T_1 \cdot (r_k)^{\gamma-1}$$

In adiabatic expansion process, i.e. 3-4,

$$\frac{T_4}{T_3} = \left(\frac{V_3}{V_4}\right)^{\gamma-1} = \left(\frac{V_2}{V_1}\right)^{\gamma-1}$$

$$\Rightarrow T_3 = T_4 \cdot (r_k)^{\gamma-1}$$

$$\begin{aligned} \eta_{th} &= 1 - \frac{T_4 - T_1}{T_4 \cdot (r_k)^{\gamma-1} - T_1 \cdot (r_k)^{\gamma-1}} \\ &= 1 - \frac{1}{(r_k)^{\gamma-1}} \end{aligned}$$

Work done (W)

$$\text{Pressure ratio, } r_p = \frac{P_3}{P_2} = \frac{P_4}{P_1}$$

$$\frac{P_2}{P_1} = \frac{P_3}{P_4} = \left(\frac{V_1}{V_2}\right)^\gamma = (r_k)^\gamma$$

$$\begin{aligned} W &= \frac{P_3 V_3 - P_4 V_4}{\gamma - 1} - \frac{P_2 V_2 - P_1 V_1}{\gamma - 1} \\ &= \frac{1}{\gamma - 1} \left[P_4 V_4 \left(\frac{P_3 V_3}{P_4 V_4} - 1 \right) - P_1 V_1 \left(\frac{P_2 V_2}{P_1 V_1} - 1 \right) \right] \\ &= \frac{1}{\gamma - 1} [P_4 V_1 (r_k^{\gamma-1} - 1) - P_1 V_1 (r_k^{\gamma-1} - 1)] \\ &= \frac{P_1 V_1}{\gamma - 1} [r_p (r_k^{\gamma-1} - 1) - (r_k^{\gamma-1} - 1)] \\ &= \frac{P_1 V_1}{\gamma - 1} [(r_k^{\gamma-1} - 1)(r_p - 1)] \end{aligned}$$

$$\text{Mean effective pressure, } P_m = \frac{\text{work done}}{\text{Swept volume}} = \frac{\text{work done}}{V_1 - V_2}$$

$$P_m = \frac{\frac{P_1 V_1}{\gamma - 1} [(r_k^{\gamma-1} - 1)(r_p - 1)]}{V_1 - V_2} = \frac{P_1 r_k [(r_k^{\gamma-1} - 1)(r_p - 1)]}{(\gamma - 1)(r_k - 1)}$$

Diesel cycle:

- Thermodynamic cycle for low speed CI/diesel engine -Reversible adiabatic compression and expansion process -Constant pressure heat addition (combustion) and heat rejection process (exhaust).
- This cycle can operate with a higher compression ratio than the Otto cycle because only air is compressed and there is no risk of auto-ignition of the fuel.

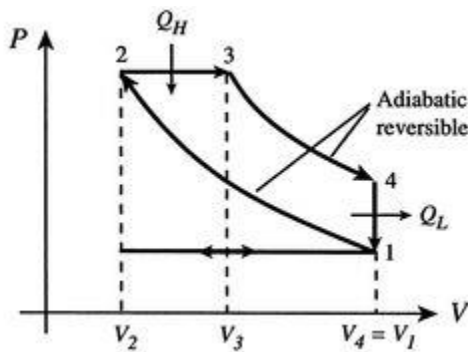

(P-V diagram)

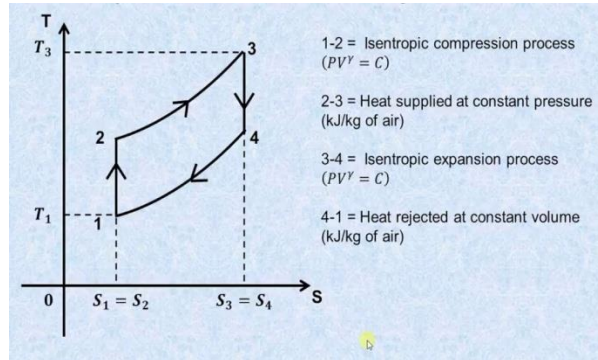

(T-S diagram)

Heat supplied, $Q_1 = C_p(T_3 - T_2)$

Heat rejection, $Q_2 = C_v(T_4 - T_1)$

Compression ratio, $r_k = \frac{V_1}{V_2}$

Cut off ratio, $r_c = \frac{V_3}{V_2}$

Thermal efficiency, $\eta_{th} = \frac{Q_1 - Q_2}{Q_1} = \frac{C_p(T_3 - T_2) - C_v(T_4 - T_1)}{C_p(T_3 - T_2)} = 1 - \frac{1}{\gamma} \frac{(T_4 - T_1)}{(T_3 - T_2)}$

In adiabatic compression process i.e. 1-2,

$$\frac{T_2}{T_1} = \left(\frac{V_1}{V_2}\right)^{\gamma-1}$$

$$\Rightarrow T_2 = T_1 \cdot (r_k)^{\gamma-1}$$

In process 2-3, pressure constant, then

$$\frac{T_3}{T_2} = \frac{V_3}{V_2} = r_c$$

$$\Rightarrow T_3 = T_2 \cdot r_c = T_1 \cdot (r_k)^{\gamma-1} \cdot r_c$$

In adiabatic expansion process i.e. 3-4,

$$\frac{T_4}{T_3} = \left(\frac{V_3}{V_4}\right)^{\gamma-1} = \left(\frac{V_3}{V_2} \cdot \frac{V_2}{V_4}\right)^{\gamma-1} = (r_c)^{\gamma-1} \cdot \frac{1}{(r_k)^{\gamma-1}}$$

$$\Rightarrow T_4 = T_3 \cdot (r_c)^{\gamma-1} \cdot \frac{1}{(r_k)^{\gamma-1}} = T_1 \cdot (r_k)^{\gamma-1} \cdot r_c \cdot (r_c)^{\gamma-1} \cdot \frac{1}{(r_k)^{\gamma-1}} = T_1 \cdot r_c$$

$$\eta_{th} = 1 - \frac{1}{\gamma} \frac{(T_4 - T_1)}{(T_3 - T_2)} = 1 - \frac{1}{\gamma \cdot (r_k)^{\gamma-1}} \left[\frac{(r_c)^{\gamma} - 1}{r_c - 1} \right]$$

Although for a given compression ratio the Otto cycle has higher efficiency, because the Diesel engine can be operated at higher compression ratio, the engine can actually have higher efficiency than an Otto cycle when both are operated at compression ratios that might be achieved in practice.

Dual combustion cycle/Dual cycle :

The combustion process in a spark ignition engine does not occur exactly at constant volume, nor does the combustion process in an actual compression ignition engine occur exactly at constant pressure, therefore another idealized cycle known as Dual cycle has been developed that more closely approximate the actual spark-ignition and compression-ignition engines.

In this cycle, part of heat addition occurs at constant volume while the rest is at constant pressure. The dual cycle is also called mixed or limited pressure cycle.

The process description of Dual cycle is as below:

- Reversible adiabatic compression (1-2)
- constant volume heat addition(2-3)
- Constant pressure heat addition(3-4)
- Reversible adiabatic expansion(4-5)
- constant volume heat rejection process(5-1)

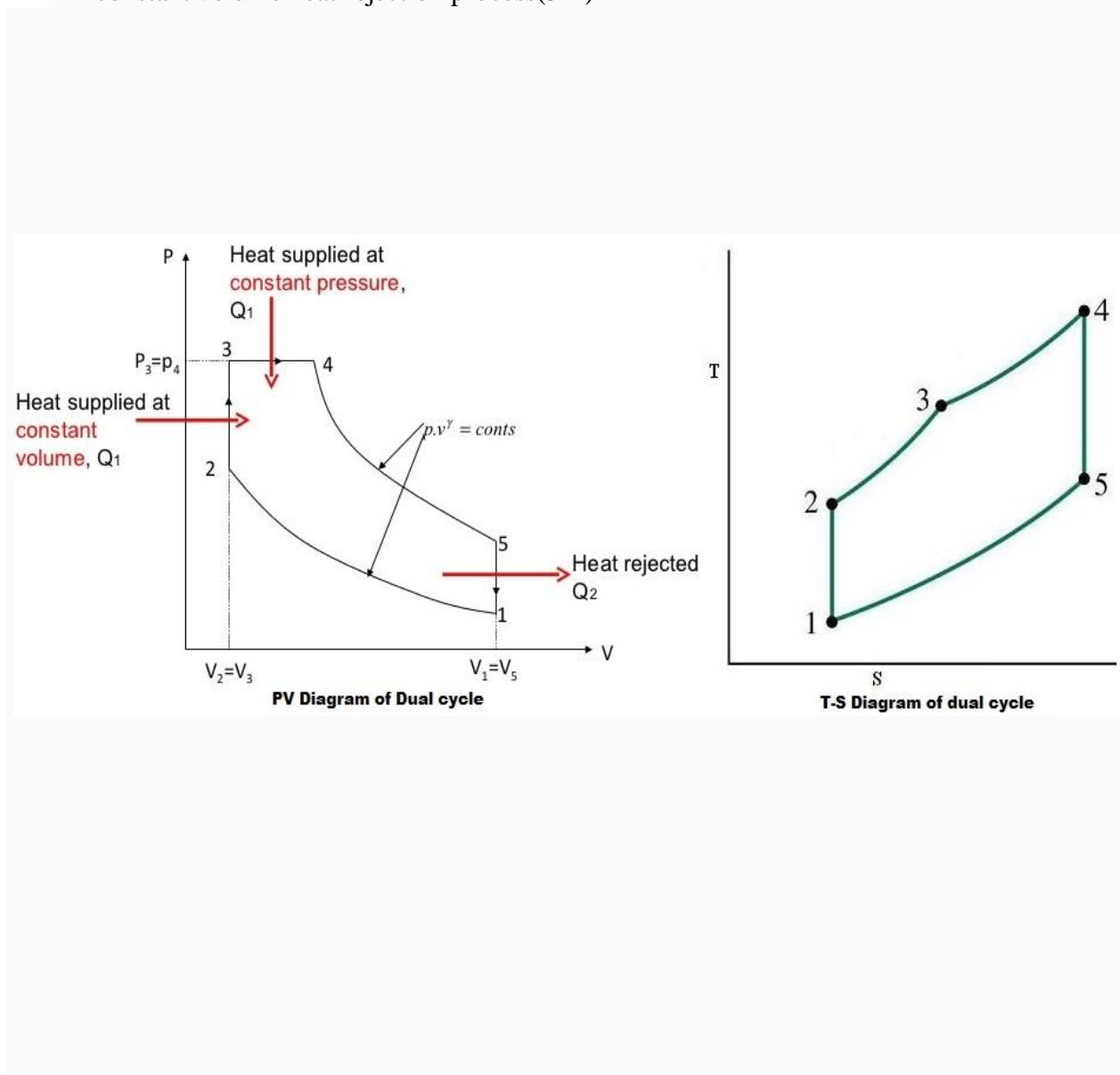

Total heat supplied, $Q_1 = C_v(T_3 - T_2) + C_p(T_4 - T_3)$

Heat rejection, $Q_2 = C_v(T_5 - T_1)$

Compression ratio, $r_k = \frac{V_1}{V_2}$

Cut off ratio, $r_c = \frac{V_4}{V_3}$

Pressure ratio, $r_p = \frac{P_3}{P_2}$

Figure 9 shows the P-V diagram of Dual cycle.

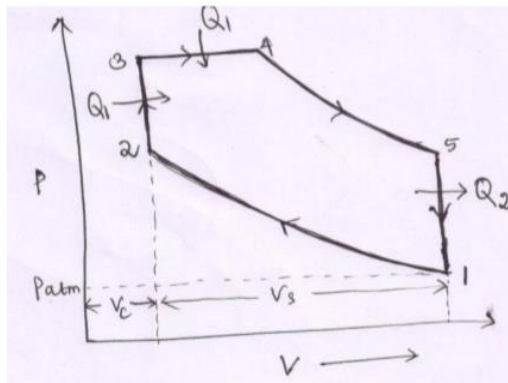

Fig. 9. Dual cycle

$$\text{Thermal efficiency, } \eta_{th} = \frac{Q_1 - Q_2}{Q_1} = \frac{C_v(T_3 - T_2) + C_p(T_4 - T_3) - C_v(T_5 - T_1)}{C_v(T_3 - T_2) + C_p(T_4 - T_3)} = 1 - \frac{(T_5 - T_1)}{(T_3 - T_2) + \gamma(T_4 - T_3)}$$

In adiabatic compression process i.e. 1-2,

$$\frac{T_2}{T_1} = \left(\frac{V_1}{V_2}\right)^{\gamma-1} = (r_k)^{\gamma-1}$$

In constant volume combustion process i.e. 2-3,

$$\frac{P_3}{P_2} = \frac{T_3}{T_2} = r_p$$

$$\Rightarrow T_2 = \frac{T_3}{r_p}$$

In constant pressure combustion process i.e. 3-4,

$$\frac{V_3}{V_4} = \frac{T_3}{T_4}$$

$$\Rightarrow T_4 = T_3 \cdot r_c$$

In adiabatic expansion process i.e. 4-5,

$$\frac{T_4}{T_5} = \left(\frac{V_5}{V_4}\right)^{\gamma-1} = \left(\frac{V_1}{V_4}\right)^{\gamma-1} = \left(\frac{r_k}{r_c}\right)^{\gamma-1}$$

$$\Rightarrow T_5 = r_c \cdot T_3 \cdot \left(\frac{r_c}{r_k}\right)^{\gamma-1}$$

$$\eta_{th} = 1 - \frac{(T_5 - T_1)}{(T_3 - T_2) + \gamma(T_4 - T_3)} = 1 - \frac{1}{(r_k)^{\gamma-1}} \left[\frac{r_p \cdot (r_c)^{\gamma-1}}{(r_p - 1) + \gamma r_p (r_c - 1)} \right]$$

Work done (W)

$$\begin{aligned} W &= P_3(V_4 - V_3) + \frac{P_4V_4 - P_5V_5}{\gamma - 1} - \frac{P_2V_2 - P_1V_1}{\gamma - 1} \\ &= P_3V_3(r_c - 1) + \frac{(P_4r_cV_3 - P_5r_kV_3) - (P_2V_3 - P_1r_kV_3)}{\gamma - 1} \\ &= \frac{P_1V_1 \cdot r_k^{\gamma-1} [\gamma r_p (r_c - 1) + (r_p - 1) - r_k^{\gamma-1} (r_p r_c^\gamma - 1)]}{\gamma - 1} \end{aligned}$$

Mean effective pressure,

$$\begin{aligned} P_m &= \frac{\frac{P_1V_1 \cdot r_k^{\gamma-1} [\gamma r_p (r_c - 1) + (r_p - 1) - r_k^{\gamma-1} (r_p r_c^\gamma - 1)]}{\gamma - 1}}{V_1 - V_2} \\ &= \frac{P_1 r_k^\gamma [\gamma r_p (r_c - 1) + (r_p - 1) - r_k^{1-\gamma} (r_p r_c^\gamma - 1)]}{(\gamma - 1)(r_k - 1)} \end{aligned}$$

Comparison of Otto, Diesel and Dual cycles:

- For Same Compression Ratio and Heat Rejection;
 $\text{Efficiency}_{\text{OTTO CYCLE}} > \text{Efficiency}_{\text{DUAL CYCLE}} > \text{Efficiency}_{\text{DIESEL CYCLE}}$

- For Same maximum pressure and heat input

Comparison of Otto, Diesel and Dual Cycles

Same maximum pressure and Heat input

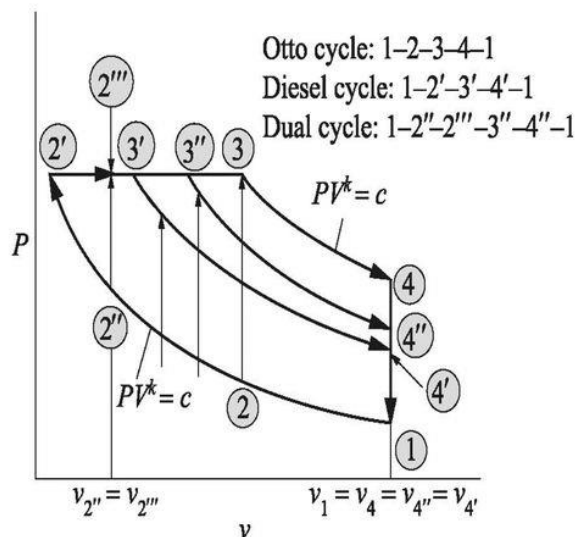

Let the three cycles operate with same maximum pressure and same heat input.

$$W_{net, Otto} = \text{area } 1-2-3-4$$

$$W_{net, Diesel} = \text{area } 1-2'-3'-4'$$

$$W_{net, Dual} = \text{area } 1-2''-2'''-3''-4''$$

It is evident that,

$$W_{net, Diesel} > W_{net, Dual} > W_{net, Otto}$$

Hence,

$$\eta_{Diesel} > \eta_{Dual} > \eta_{Otto}$$

Chapter-6

Fuels and combustion:

Fuel:

We always need a certain substance to convert one form of energy into another for accomplishing various jobs. We call such materials as fuels. In other words, any substance which upon combustion produces a usable amount of energy is known as **fuel**. Example: fossil fuels, biogas, nuclear energy, etc.

Some properties of ideal fuel are:

- An ideal fuel is readily available.
- An ideal fuel is cheap.
- An ideal fuel burns easily in the air at a moderate rate.
- It releases a large amount of energy.
- It should not leave behind any undesirable substances which can be harmful to us.
- It should not affect the environment adversely.

Types of Fuels:

Fuels can be generally classified into two factors:

1. On the basis of their fuels state:
 - Solid Fuels
 - Liquid Fuels
 - Gaseous Fuels
2. On the basis of their occurrence:
 - Natural Fuels
 - Artificial Fuels

Examples of Fuels:

Natural Fuels	Artificial Fuels
Solid Fuels	
Wood, Coal, Oil Shale	Tanbark, Bagasse, Straw, Charcoal, Coal, Briquettes

Liquid Fuels	
Petroleum	Oils from distillation of petroleum, Coal Tar, Shale-Oil, Alcohols, etc.
Gaseous Fuels	
Natural Gas	Coal gas, Producer Gas, Water Gas, Hydrogen, Acetylene, Blast Furnace Gas, Oil Gas

Solid Fuels:

Fuels which are found in their solid state at room temperature are generally referred to as Solid Fuels. They were the first kind of fuel known to be used by man, basically wood to create fire. Coal was another one of the influential fuels known to man as it leads the way for the industrial revolution, from firing furnaces to running steam engines.

Advantages:

- Easier transportation and storage.
- Low production cost.
- Moderate ignition temperature.

Disadvantages:

- Large portion of energy is wasted.
- Cost of handling is high and controlling is also hard.
- Ash content is high & burn with clinker formation.

Liquid Fuel:

Most liquid fuels are derived from the fossilized remains of dead plants and animals by exposure to heat and pressure in the Earth's crust. The fumes of the liquid fuel are flammable instead of the liquid.

Advantages:

- Higher calorific value per unit mass.
- Burn without ash, clinkers, etc.

- Controlling the combustion is easier.
- Transportation easier through pipes and stored indefinitely without loss.
- Loss of energy is comparatively lower.
- Require less furnace space for combustion.

Disadvantages:

- Cost of liquid fuel is much higher compared to solid fuel.
- Storage methods are costlier.
- Greater risk of fire hazards.
- Special burning equipment required for more efficient combustion.

Gaseous Fuel:

Gaseous fuels occur in nature, besides being manufactured from solid and liquid fuels. Most gaseous fuels are composed of hydrocarbons, carbon monoxide, hydrogen or a mixture of them all.

Advantages:

- Transportation through pipes is easy.
- Sparking combustion is really easy.
- They have a higher heat content.
- Clean after use.
- Do Not require any special burner technology.

Disadvantages:

- Large storage tanks required.
- As they are highly inflammable, the chance for fire hazards are extremely high and strict safety measures need to be followed.

What are fossil fuels?

Fossil fuels are the dead and decayed remains of plants and animals subjected to decades of pressure and temperature under the earth's crust. Primarily fossil fuels are hydrocarbons. They are convenient and effective. They provide the calorific value required to fulfil our needs. Even though they are available in plenty right now, they are a non-renewable source of energy. The burning of fossil fuels is responsible for a large section of the world's pollution index.

Types of fossil fuels:

- Coal
- Oil
- Natural Gas

Nuclear Fuel:

Any material consumed to give out nuclear energy is a nuclear fuel. Technically speaking, any material can be made to give out nuclear energy. But looking at its practicality and feasibility, we pick materials which do not require extreme constraints to release nuclear energy.

Most nuclear fuels contain heavy fissile elements that are capable of nuclear fission. When these fuels are struck by neutrons, they are in turn capable of emitting neutrons when they break apart. This makes possible a self-sustaining chain reaction that releases energy at a controlled rate in a nuclear reactor or with a very rapid uncontrolled rate of a nuclear weapon.

Some common examples of nuclear fuel are uranium-235 (^{235}U) and plutonium-239 (^{239}Pu).

Heating values of fuel:

The heat value of a fuel is the amount of heat released during its combustion. Also referred to as energy or calorific value, heat value is a measure of a fuel's energy density, and is expressed in energy (joules) per specified amount (*e.g.* kilograms).

FUEL	Heating value
Hydrogen (H_2)	120-142 MJ/kg
Methane (CH_4)	50-55 MJ/kg
Methanol (CH_3OH)	22.7 MJ/kg
Dimethyl ether - DME (CH_3OCH_3)	29 MJ/kg
Petrol/gasoline	44-46 MJ/kg
Diesel fuel	42-46 MJ/kg
Crude oil	42-47 MJ/kg
Liquefied petroleum gas (LPG)	46-51 MJ/kg
Natural gas	42-55 MJ/kg
Hard black coal (IEA definition)	>23.9 MJ/kg
Hard black coal (Australia & Canada)	c. 25 MJ/kg
Sub-bituminous coal (IEA definition)	17.4-23.9 MJ/kg
Sub-bituminous coal (Australia & Canada)	c. 18 MJ/kg
Lignite/brown coal (IEA definition)	<17.4 MJ/kg
Lignite/brown coal (Australia, electricity)	c. 10 MJ/kg
Firewood (dry)	16 MJ/kg
Natural uranium, in LWR (normal reactor)	500 GJ/kg
Natural uranium, in LWR with U & Pu recycle	650 GJ/kg
Natural uranium, in FNR	28,000 GJ/kg
Uranium enriched to 3.5%, in LWR	3900 GJ/kg

Uranium figures are based on 45,000 MWd/t burn-up of 3.5% enriched U in LWR

MJ = 10^6 Joule, GJ = 10^9 J

MJ to kWh @ 33% efficiency: x 0.0926

One tonne of oil equivalent (toe) is equal to 41.868 GJ

Calorific value of fuel:

Calorific value is the amount of heat energy present in food or fuel and which is determined by the complete combustion of specified quantity at constant pressure and in normal conditions. It is also called calorific power. The unit of calorific value is kilojoule per kilogram i.e. KJ/Kg.

<u>Fuel</u>	<u>Calorific values</u>
Cow Dung	8000 KJ/Kg
Wood	22000 KJ/Kg
Coal	33000 KJ/Kg
Biogas	40000 KJ/Kg
Diesel	45000 KJ/Kg
kerosene	45000 KJ/Kg
Petrol	45000 KJ/Kg
Methane	50000 KJ/Kg
LPG	55000 KJ/Kg

Quality of I.C engine fuels:

Octane number:

Octane number indicates the tendency of fuels to knock. The higher the octane number the more difficult the auto-ignition.

- n-Heptane (C₇H₁₆) has a octane number 0,
- iso-octane (C₈H₁₈) has a octane number 100.
- Gasoline has a octane number 93 – 97.

Cetane number:

It can be defined as the percentage by volume of normal cetane in a mixture of normal cetane and alpha methyl naphthalene which has the same ignition characteristics as the test fuel when combustion is carried out in a standard engine under a set of specified working conditions.

Difference between octane number and cetane number:

Octane number	Cetane number
The octane number of a fuel may be defined as the percentage of iso-octane in a mixture of iso-octane and n-heptane which just matches with the knocking tendency of the fuel under test.	The cetane number of diesel oil is defined as the percentage by volume of cetane in a mixture of cetane and α -methyl naphthalene which exactly matches in its knocking characteristics with the oil under test.
The octane Number is a measure of the auto ignition resistance of gasoline (petrol) and other fuels used in spark-ignition internal combustion engines.	The Cetane Number is a measure of the combustion quality of diesel fuel under compression.
The higher the octane number, the better is the resistance of Gasoline to combustion prematurely, known as Knocking .	The Higher Cetane number means that the Diesel will ignite readily and, therefore, perform better in a diesel engine
Isooctane is given a maximum octane number, i.e. 100 . n-heptane is given a minimum octane number, i.e. 0 .	Cetane is given a maximum cetane number, i.e. 100 while α -methylnaphthalene is given a minimum cetane number, i.e. 0 .
Octane numbers are only used between 0 and 100. The fuels having better anti-knocking property than isooctane are rated in other scales like octane Performance.	Cetane numbers are only used for the relatively light distillate diesel oils. For heavy (residual) fuel oil two other scales are used CCAI and CII